



CprE 281: Digital Logic

Instructor: Alexander Stoytchev

<http://www.ece.iastate.edu/~alexs/classes/>

Minimization

*CprE 281: Digital Logic
Iowa State University, Ames, IA
Copyright © Alexander Stoytchev*

Administrative Stuff

- **HW4 is out**
- **It is due on Monday Sep 14 @ 4 pm**
- **It is posted on the class web page**
- **I also sent you an e-mail with the link.**

Expressions with three variables (for three-variable K-maps)

Groupings and Expressions

		x_1x_2			
		00	01	11	10
x_3	0	1	0	0	0
	1	0	0	0	0

$$\overline{x_1} \overline{x_2} \overline{x_3}$$

		x_1x_2			
		00	01	11	10
x_3	0	0	1	0	0
	1	0	0	0	0

$$\overline{x_1} x_2 \overline{x_3}$$

		x_1x_2			
		00	01	11	10
x_3	0	0	0	1	0
	1	0	0	0	0

$$x_1 x_2 \overline{x_3}$$

		x_1x_2			
		00	01	11	10
x_3	0	0	0	0	1
	1	0	0	0	0

$$x_1 \overline{x_2} \overline{x_3}$$

Groupings and Expressions

		x_1x_2			
		00	01	11	10
x_3	0	0	0	0	0
	1	1	0	0	0

$$\overline{\overline{x_1}} \overline{\overline{x_2}} x_3$$

		x_1x_2			
		00	01	11	10
x_3	0	0	0	0	0
	1	0	1	0	0

$$\overline{\overline{x_1}} x_2 \overline{\overline{x_3}}$$

		x_1x_2			
		00	01	11	10
x_3	0	0	0	0	0
	1	0	0	1	0

$$x_1 x_2 x_3$$

		x_1x_2			
		00	01	11	10
x_3	0	0	0	0	0
	1	0	0	0	1

$$x_1 \overline{\overline{x_2}} \overline{\overline{x_3}}$$

Expressions with two variables (for three-variable K-maps)

Groupings and Expressions

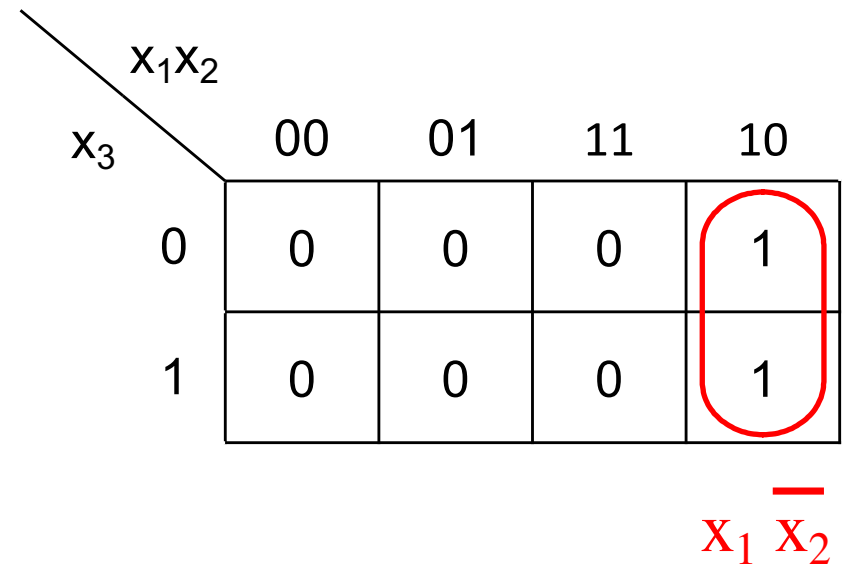
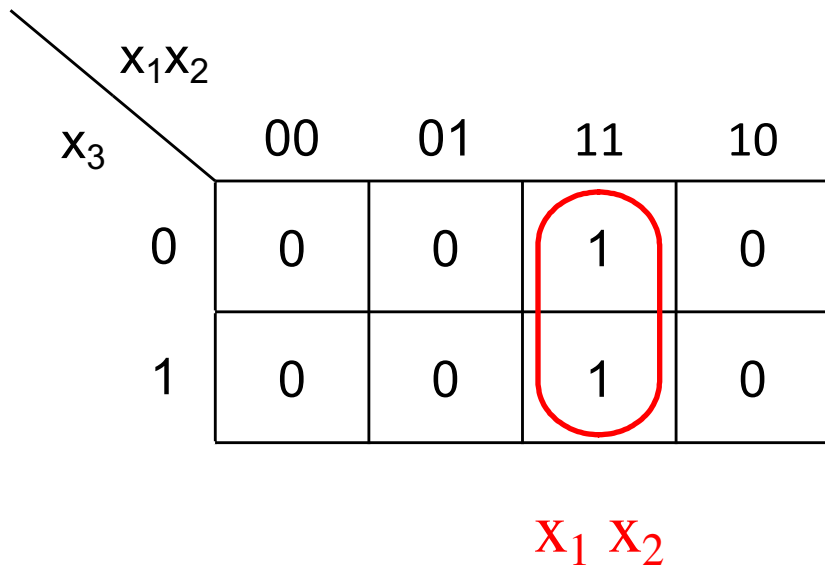
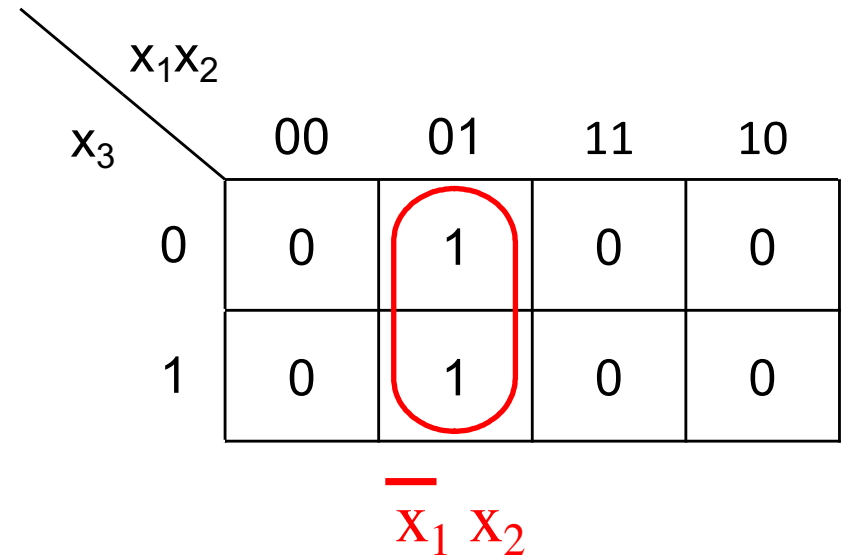
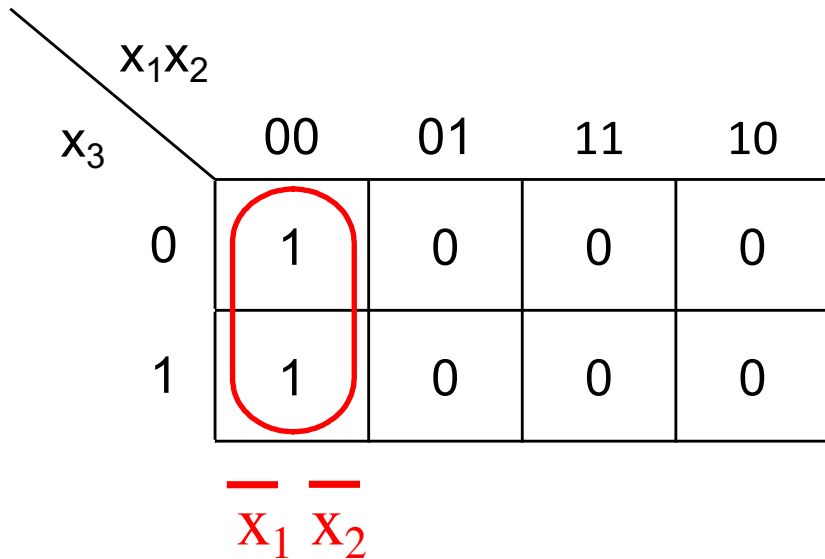

Groupings and Expressions

		x_1x_2			
		00	01	11	10
x_3	0	1	1	0	0
	1	0	0	0	0

$$\overline{x_1} \overline{x_3}$$

		x_1x_2			
		00	01	11	10
x_3	0	0	1	1	0
	1	0	0	0	0

$$\overline{x_2} \overline{x_3}$$

		x_1x_2			
		00	01	11	10
x_3	0	0	0	1	1
	1	0	0	0	0

$$\overline{x_1} \overline{x_3}$$

		x_1x_2			
		00	01	11	10
x_3	0	1	0	0	1
	1	0	0	0	0

$$\overline{x_2} \overline{x_3}$$

Groupings and Expressions

		x_1x_2			
		00	01	11	10
x_3	0	0	0	0	0
	1	1	1	0	0

$$\overline{x_1} x_3$$

		x_1x_2			
		00	01	11	10
x_3	0	0	0	0	0
	1	0	1	1	0

$$x_2 x_3$$

		x_1x_2			
		00	01	11	10
x_3	0	0	0	0	0
	1	0	0	1	1

$$x_1 x_3$$

		x_1x_2			
		00	01	11	10
x_3	0	0	0	0	0
	1	1	0	0	1

$$\overline{x_2} x_3$$

Expressions with one variable (for three-variable K-maps)

Groupings and Expressions

		x_1x_2			
		00	01	11	10
x_3	0	1	1	0	0
	1	1	1	0	0

$\overline{x_1}$

		x_1x_2			
		00	01	11	10
x_3	0	0	1	1	0
	1	0	1	1	0

x_2

		x_1x_2			
		00	01	11	10
x_3	0	0	0	1	1
	1	0	0	1	1

x_1

		x_1x_2			
		00	01	11	10
x_3	0	1	0	0	1
	1	1	0	0	1

$\overline{x_2}$

Groupings and Expressions

		x_1x_2			
		00	01	11	10
x_3	0	1	1	1	1
	1	0	0	0	0

$\overline{x_3}$

		x_1x_2			
		00	01	11	10
x_3	0	0	0	0	0
	1	1	1	1	1

x_3

**Expressions with zero variables
(for three-variable K-maps)**

Groupings and Expressions

		x_1x_2			
		00	01	11	10
x_3	0	0	0	0	0
	1	0	0	0	0

0

		x_1x_2			
		00	01	11	10
x_3	0	1	1	1	1
	1	1	1	1	1

1

Grouping Size v.s. Term Size (for 3-variable K-maps)

Grouping Size v.s. Term Size

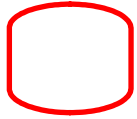

3-variable term



2-variable term



1-variable term



0-variable term

Grouping Size v.s. Term Size

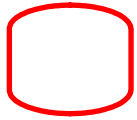

3-variable term

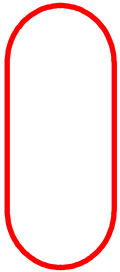

2-variable term

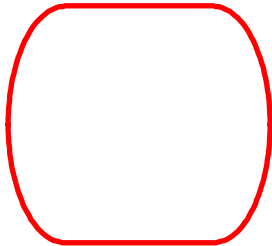

1-variable term



0-variable term

Grouping Size v.s. Term Size (for 4-variable K-maps)

Grouping Size v.s. Term Size

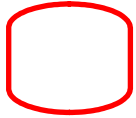

4-variable term

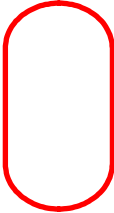

3-variable term

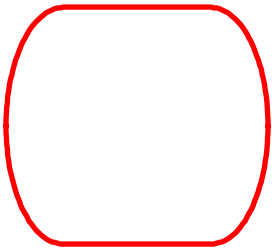

2-variable term



1-variable term



0-variable term

Grouping Size v.s. Term Size

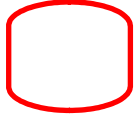

4-variable term



3-variable term



2-variable term

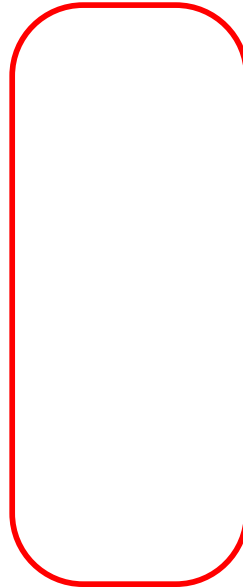

1-variable term



0-variable term

Grouping Size v.s. Term Size (for 2-variable K-maps)

Grouping Size v.s. Term Size

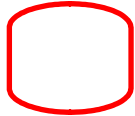

2-variable term

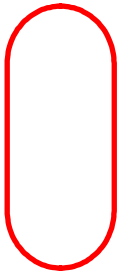

1-variable term

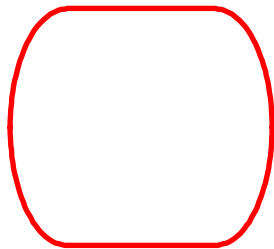

0-variable term

Grouping Size v.s. Term Size

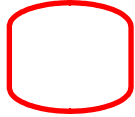

2-variable term



1-variable term

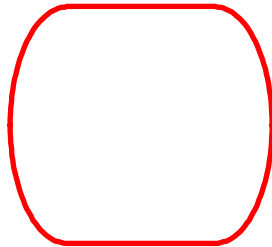

0-variable term

Grouping Size v.s. Term Size

2-variable
K-map

3-variable
K-map

4-variable
K-map

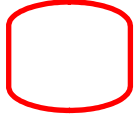

2

3

4

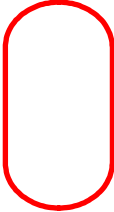

1

2

3

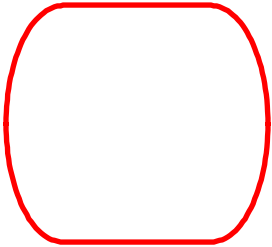

0

1

2



N/A

0

1



N/A

N/A

0

Example:
K-Map for the 2-1 Multiplexer

2-1 Multiplexer (Definition)

- **Has two inputs: x_1 and x_2**
- **Also has another input line s**
- **If $s=0$, then the output is equal to x_1**
- **If $s=1$, then the output is equal to x_2**

Circuit for 2-1 Multiplexer

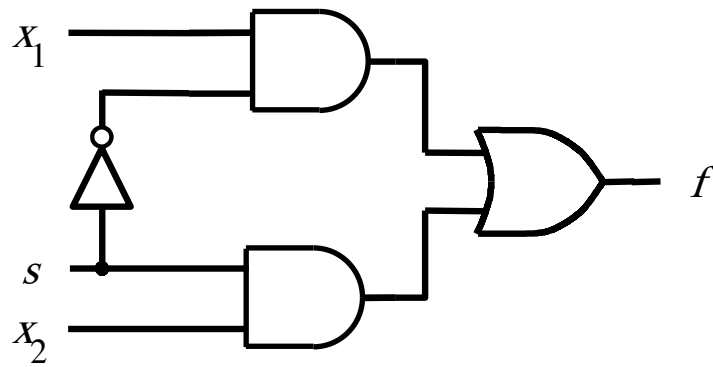

(b) Circuit

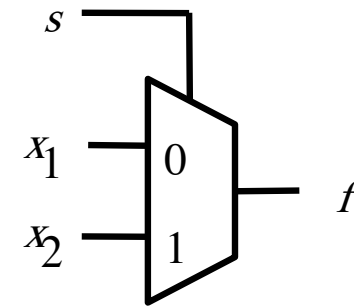

(c) Graphical symbol

Truth Table for a 2-1 Multiplexer

s x_1 x_2	$f(s, x_1, x_2)$
0 0 0	0
0 0 1	0
0 1 0	1
0 1 1	1
1 0 0	0
1 0 1	1
1 1 0	0
1 1 1	1

Let's Draw the K-map

$s \ x_1 \ x_2$	$f(s, x_1, x_2)$
0 0 0	0
0 0 1	0
0 1 0	1
0 1 1	1
1 0 0	0
1 0 1	1
1 1 0	0
1 1 1	1

[Figure 2.33a from the textbook]

Let's Draw the K-map

	s	x_1	x_2	$f(s, x_1, x_2)$
m_0	0	0	0	0
m_1	0	0	1	0
m_2	0	1	0	1
m_3	0	1	1	1
m_4	1	0	0	0
m_5	1	0	1	1
m_6	1	1	0	0
m_7	1	1	1	1

Let's Draw the K-map

	s	x_1	x_2	$f(s, x_1, x_2)$
m_0	0	0	0	0
m_1	0	0	1	0
m_2	0	1	0	1
m_3	0	1	1	1
m_4	1	0	0	0
m_5	1	0	1	1
m_6	1	1	0	0
m_7	1	1	1	1

		$x_1 x_2$			
		00	01	11	10
s	0	m_0	m_2	m_6	m_4
	1	m_1	m_3	m_7	m_5

Let's Draw the K-map

	s	x_1	x_2	$f(s, x_1, x_2)$
m_0	0	0	0	0
m_1	0	0	1	0
m_2	0	1	0	1
m_3	0	1	1	1
m_4	1	0	0	0
m_5	1	0	1	1
m_6	1	1	0	0
m_7	1	1	1	1

		$x_1 x_2$			
		00	01	11	10
s	0	0	1	0	0
	1	0	1	1	1

Let's Draw the K-map

	s	x_1	x_2	$f(s, x_1, x_2)$
m_0	0	0	0	0
m_1	0	0	1	0
m_2	0	1	0	1
m_3	0	1	1	1
m_4	1	0	0	0
m_5	1	0	1	1
m_6	1	1	0	0
m_7	1	1	1	1

A Karnaugh map for the function $f(s, x_1, x_2)$. The vertical axis is labeled s with values 0 and 1. The horizontal axis is labeled x_1x_2 with values 00, 01, 11, and 10. The map contains the following values:

$s \backslash x_1x_2$	00	01	11	10
0	0	1	0	0
1	0	1	1	1

Two groups of 1s are circled in cyan:

- A vertical group of two 1s in the $x_1x_2 = 01$ column, spanning $s = 0$ and $s = 1$.
- A horizontal group of two 1s in the $s = 1$ row, spanning $x_1x_2 = 11$ and $x_1x_2 = 10$.

Vertical lines extend downwards from the bottom of each cyan circle.

Let's Draw the K-map

	s	x_1	x_2	$f(s, x_1, x_2)$
m_0	0	0	0	0
m_1	0	0	1	0
m_2	0	1	0	1
m_3	0	1	1	1
m_4	1	0	0	0
m_5	1	0	1	1
m_6	1	1	0	0
m_7	1	1	1	1

$s \backslash x_1 x_2$	00	01	11	10
0	0	1	0	0
1	0	1	1	1

$$f(s, x_1, x_2) = \bar{x}_1 x_2 + s x_1$$

Let's Draw the K-map

	s	x_1	x_2	$f(s, x_1, x_2)$
m_0	0	0	0	0
m_1	0	0	1	0
m_2	0	1	0	1
m_3	0	1	1	1
m_4	1	0	0	0
m_5	1	0	1	1
m_6	1	1	0	0
m_7	1	1	1	1

$s \backslash x_1 x_2$	00	01	11	10
0	0	1	0	0
1	0	1	1	1

$$f(s, x_1, x_2) = \bar{x}_1 x_2 + s x_1$$

Something is wrong!

Compare this with the SOP derivation

Let's Derive the SOP form

$s \ x_1 \ x_2$	$f(s, x_1, x_2)$
0 0 0	0
0 0 1	0
0 1 0	1
0 1 1	1
1 0 0	0
1 0 1	1
1 1 0	0
1 1 1	1

Let's Derive the SOP form

$s \ x_1 \ x_2$	$f(s, x_1, x_2)$
0 0 0	0
0 0 1	0
0 1 0	1
0 1 1	1
1 0 0	0
1 0 1	1
1 1 0	0
1 1 1	1

Let's Derive the SOP form

$s \ x_1 \ x_2$	$f(s, x_1, x_2)$
0 0 0	0
0 0 1	0
0 1 0	1
0 1 1	1
1 0 0	0
1 0 1	1
1 1 0	0
1 1 1	1

Where should we
put the negation signs?

$s \ x_1 \ x_2$

$s \ x_1 \ x_2$

$s \ x_1 \ x_2$

$s \ x_1 \ x_2$

Let's Derive the SOP form

$s \ x_1 \ x_2$	$f(s, x_1, x_2)$	
0 0 0	0	
0 0 1	0	
0 1 0	1	$\bar{s} \ x_1 \ \bar{x}_2$
0 1 1	1	$\bar{s} \ x_1 \ x_2$
1 0 0	0	
1 0 1	1	$s \ \bar{x}_1 \ x_2$
1 1 0	0	
1 1 1	1	$s \ x_1 \ x_2$

Let's Derive the SOP form

$s \ x_1 \ x_2$	$f(s, x_1, x_2)$	
0 0 0	0	
0 0 1	0	
0 1 0	1	$\bar{s} x_1 \bar{x}_2$
0 1 1	1	$\bar{s} x_1 x_2$
1 0 0	0	
1 0 1	1	$s \bar{x}_1 x_2$
1 1 0	0	
1 1 1	1	$s x_1 x_2$

$$f(s, x_1, x_2) = \bar{s} x_1 \bar{x}_2 + \bar{s} x_1 x_2 + s \bar{x}_1 x_2 + s x_1 x_2$$

Let's simplify this expression

$$f(s, x_1, x_2) = \bar{s} x_1 \bar{x}_2 + \bar{s} x_1 x_2 + s \bar{x}_1 x_2 + s x_1 x_2$$

Let's simplify this expression

$$f(s, x_1, x_2) = \bar{s} x_1 \bar{x}_2 + \bar{s} x_1 x_2 + s \bar{x}_1 x_2 + s x_1 x_2$$

$$f(s, x_1, x_2) = \bar{s} x_1 (\bar{x}_2 + x_2) + s (\bar{x}_1 + x_1) x_2$$

Let's simplify this expression

$$f(s, x_1, x_2) = \bar{s} x_1 \bar{x}_2 + \bar{s} x_1 x_2 + s \bar{x}_1 x_2 + s x_1 x_2$$

$$f(s, x_1, x_2) = \bar{s} x_1 (\bar{x}_2 + x_2) + s (\bar{x}_1 + x_1) x_2$$

$$f(s, x_1, x_2) = \bar{s} x_1 + s x_2$$

Let's Draw the K-map again

$s \ x_1 \ x_2$	$f(s, x_1, x_2)$
0 0 0	0
0 0 1	0
0 1 0	1
0 1 1	1
1 0 0	0
1 0 1	1
1 1 0	0
1 1 1	1

[Figure 2.33a from the textbook]

Let's Draw the K-map again

	s	x_1	x_2	$f(s, x_1, x_2)$
m_0	0	0	0	0
m_1	0	0	1	0
m_2	0	1	0	1
m_3	0	1	1	1
m_4	1	0	0	0
m_5	1	0	1	1
m_6	1	1	0	0
m_7	1	1	1	1

Let's Draw the K-map again

	s	x_1	x_2	$f(s, x_1, x_2)$
m_0	0	0	0	0
m_1	0	0	1	0
m_2	0	1	0	1
m_3	0	1	1	1
m_4	1	0	0	0
m_5	1	0	1	1
m_6	1	1	0	0
m_7	1	1	1	1

		x_1x_2			
		00	01	11	10
s	0	m_0	m_2	m_6	m_4
	1	m_1	m_3	m_7	m_5

Let's Draw the K-map again

	s	x_1	x_2	$f(s, x_1, x_2)$
m_0	0	0	0	0
m_1	0	0	1	0
m_2	0	1	0	1
m_3	0	1	1	1
m_4	1	0	0	0
m_5	1	0	1	1
m_6	1	1	0	0
m_7	1	1	1	1

	s	$x_1 x_2$	00	01	11	10
0			m_0	m_2	m_6	m_4
1			m_1	m_3	m_7	m_5

Let's Draw the K-map again

	s	x_1	x_2	$f(s, x_1, x_2)$
m_0	0	0	0	0
m_1	0	0	1	0
m_2	0	1	0	1
m_3	0	1	1	1
m_4	1	0	0	0
m_5	1	0	1	1
m_6	1	1	0	0
m_7	1	1	1	1

	s	x_1	x_2	
	00	01	11	10
0	m_0	m_2	m_6	m_4
1	m_1	m_3	m_7	m_5

The order of the labeling matters.

Let's Draw the K-map again

	s	x_1	x_2	$f(s, x_1, x_2)$
m_0	0	0	0	0
m_1	0	0	1	0
m_2	0	1	0	1
m_3	0	1	1	1
m_4	1	0	0	0
m_5	1	0	1	1
m_6	1	1	0	0
m_7	1	1	1	1

		$s x_1$			
		00	01	11	10
x_2	0	m_0	m_2	m_6	m_4
	1	m_1	m_3	m_7	m_5

Let's Draw the K-map again

	s	x_1	x_2	$f(s, x_1, x_2)$
m_0	0	0	0	0
m_1	0	0	1	0
m_2	0	1	0	1
m_3	0	1	1	1
m_4	1	0	0	0
m_5	1	0	1	1
m_6	1	1	0	0
m_7	1	1	1	1

		$s x_1$			
		00	01	11	10
x_2	0	0	1	0	0
	1	0	1	1	1

Let's Draw the K-map again

	s	x_1	x_2	$f(s, x_1, x_2)$
m_0	0	0	0	0
m_1	0	0	1	0
m_2	0	1	0	1
m_3	0	1	1	1
m_4	1	0	0	0
m_5	1	0	1	1
m_6	1	1	0	0
m_7	1	1	1	1

A Karnaugh map for the function $f(s, x_1, x_2)$. The vertical axis is labeled x_2 with values 0 and 1. The horizontal axis is labeled $s x_1$ with values 00, 01, 11, and 10. The map contains 1s at the following cells: (0, 01), (1, 01), (1, 11), and (1, 10). Two groups are circled in cyan: a vertical group covering the 1s at (0, 01) and (1, 01), and a horizontal group covering the 1s at (1, 11) and (1, 10). Vertical lines extend from the bottom of each group.

x_2	$s x_1$	00	01	11	10
0		0	1	0	0
1		0	1	1	1

Let's Draw the K-map again

	s	x_1	x_2	$f(s, x_1, x_2)$
m_0	0	0	0	0
m_1	0	0	1	0
m_2	0	1	0	1
m_3	0	1	1	1
m_4	1	0	0	0
m_5	1	0	1	1
m_6	1	1	0	0
m_7	1	1	1	1

		$s x_1$			
		00	01	11	10
x_2	0	0	1	0	0
	1	0	1	1	1

$$f(s, x_1, x_2) = \bar{s} x_1 + s x_2$$

This is correct!

Two Different Ways to Draw the K-map

x_1	x_2	x_3	
0	0	0	m_0
0	0	1	m_1
0	1	0	m_2
0	1	1	m_3
1	0	0	m_4
1	0	1	m_5
1	1	0	m_6
1	1	1	m_7

(a) Truth table

		$x_1 x_2$			
		00	01	11	10
x_3	0	m_0	m_2	m_6	m_4
	1	m_1	m_3	m_7	m_5

(b) Karnaugh map

		$x_2 x_3$			
		00	01	11	10
x_1	0	m_0	m_1	m_3	m_2
	1	m_4	m_5	m_7	m_6

Another Way to Draw 3-variable K-map

x_1	x_2	x_3	
0	0	0	m_0
0	0	1	m_1
0	1	0	m_2
0	1	1	m_3
1	0	0	m_4
1	0	1	m_5
1	1	0	m_6
1	1	1	m_7

(a) Truth table

		$x_1 x_2$			
		00	01	11	10
x_3	0	m_0	m_2	m_6	m_4
	1	m_1	m_3	m_7	m_5

(b) Karnaugh map

		x_1	
		0	1
$x_2 x_3$	00	m_0	m_4
	01	m_1	m_5
	11	m_3	m_7
	10	m_2	m_6

There are 4 different versions!

		x_1x_2			
		00	01	11	10
x_3	0	m_0	m_2	m_6	m_4
	1	m_1	m_3	m_7	m_5

		x_2x_3			
		00	01	11	10
x_1	0	m_0	m_1	m_3	m_2
	1	m_4	m_5	m_7	m_6

		x_3	
		0	1
x_1x_2	00	m_0	m_1
	01	m_2	m_3
	11	m_6	m_7
	10	m_4	m_5

		x_1	
		0	1
x_2x_3	00	m_0	m_4
	01	m_1	m_5
	11	m_3	m_7
	10	m_2	m_6

Gray Code

- **Sequence of binary codes**
- **Neighboring lines vary by only 1 bit**

	000
	001
00	011
01	010
11	110
10	111
	101
	100

Gray Code & K-map

	s	x_1	x_2
m_0	0	0	0
m_1	0	0	1
m_2	0	1	0
m_3	0	1	1
m_4	1	0	0
m_5	1	0	1
m_6	1	1	0
m_7	1	1	1

		$s x_1$			
		00	01	11	10
x_2	0	m_0	m_2	m_6	m_4
	1	m_1	m_3	m_7	m_5

Gray Code & K-map

	s	x_1	x_2
m_0	0	0	0
m_1	0	0	1
m_2	0	1	0
m_3	0	1	1
m_4	1	0	0
m_5	1	0	1
m_6	1	1	0
m_7	1	1	1

		$s x_1$			
		00	01	11	10
x_2	0	000	010	110	100
	1	001	011	111	101

Gray Code & K-map

	s	x_1	x_2
m_0	0	0	0
m_1	0	0	1
m_2	0	1	0
m_3	0	1	1
m_4	1	0	0
m_5	1	0	1
m_6	1	1	0
m_7	1	1	1

		$s x_1$			
		00	01	11	10
x_2	0	000	010	110	100
	1	001	011	111	101

These two neighbors
differ only in the LAST bit

Gray Code & K-map

	s	x_1	x_2
m_0	0	0	0
m_1	0	0	1
m_2	0	1	0
m_3	0	1	1
m_4	1	0	0
m_5	1	0	1
m_6	1	1	0
m_7	1	1	1

		$s x_1$			
		00	01	11	10
x_2	0	000	010	110	100
	1	001	011	111	101

These two neighbors
differ only in the LAST bit

Gray Code & K-map

	s	x_1	x_2
m_0	0	0	0
m_1	0	0	1
m_2	0	1	0
m_3	0	1	1
m_4	1	0	0
m_5	1	0	1
m_6	1	1	0
m_7	1	1	1

		$s \ x_1$			
		00	01	11	10
x_2	0	000	010	110	100
	1	001	011	111	101

These two neighbors
differ only in the FIRST bit

Gray Code & K-map

	s	x_1	x_2
m_0	0	0	0
m_1	0	0	1
m_2	0	1	0
m_3	0	1	1
m_4	1	0	0
m_5	1	0	1
m_6	1	1	0
m_7	1	1	1

x_2	$s x_1$			
	00	01	11	10
0	000	010	110	100
1	001	011	111	101

These two neighbors
differ only in the FIRST bit

Adjacency Rules

$x_2 \backslash s x_1$	00	01	11	10
0	000	010	110	100
1	001	011	111	101

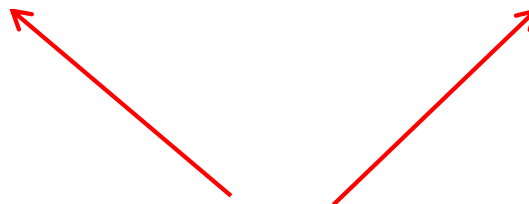

adjacent
columns

Gray Code & K-map

	s	x_1	x_2
m_0	0	0	0
m_1	0	0	1
m_2	0	1	0
m_3	0	1	1
m_4	1	0	0
m_5	1	0	1
m_6	1	1	0
m_7	1	1	1

		$s \ x_1$			
		00	01	11	10
x_2	0	000	010	110	100
	1	001	011	111	101

These four neighbors
differ in the FIRST and LAST bit

They are similar in their MIDDLE bit

Gray Code & K-map

	s	x_1	x_2
m_0	0	0	0
m_1	0	0	1
m_2	0	1	0
m_3	0	1	1
m_4	1	0	0
m_5	1	0	1
m_6	1	1	0
m_7	1	1	1

x_2	$s x_1$			
	00	01	11	10
0	000	010	110	100
1	001	011	111	101

These four neighbors
differ in the FIRST and LAST bit

They are similar in their MIDDLE bit

A four-variable Karnaugh map

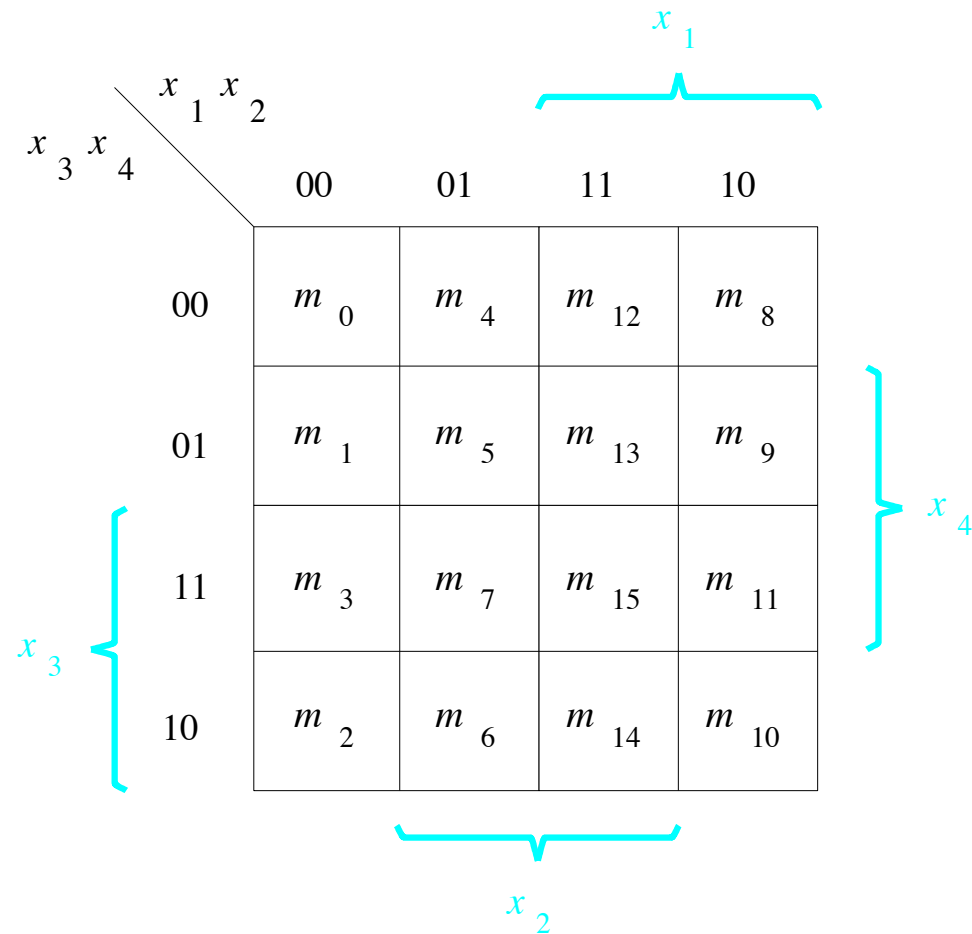

A four-variable Karnaugh map

x1	x2	x3	x4	
0	0	0	0	m0
0	0	0	1	m1
0	0	1	0	m2
0	0	1	1	m3
<hr/>				
0	1	0	0	m4
0	1	0	1	m5
0	1	1	0	m6
0	1	1	1	m7
<hr/>				
1	0	0	0	m8
1	0	0	1	m9
1	0	1	0	m10
1	0	1	1	m11
<hr/>				
1	1	0	0	m12
1	1	0	1	m13
1	1	1	0	m14
1	1	1	1	m15

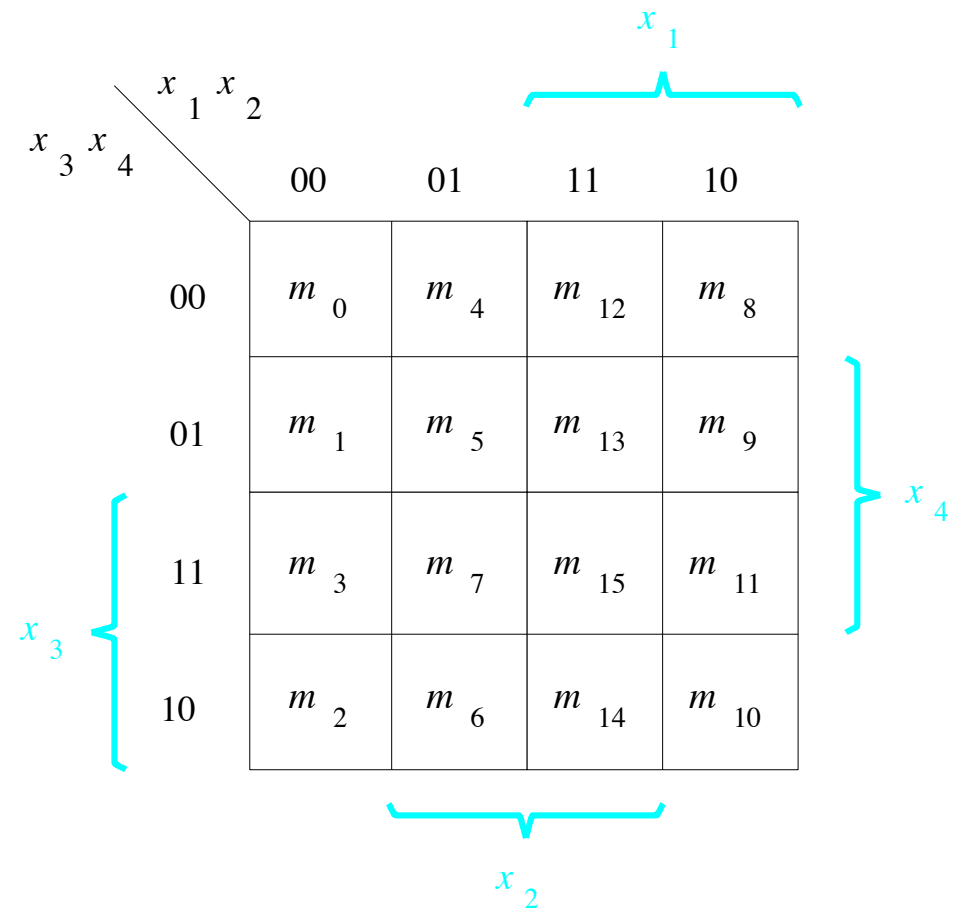

Adjacency Rules

x_3 \ x_1x_2	00	01	11	10
0	m_0	m_2	m_6	m_4
1	m_1	m_3	m_7	m_5

adjacent
columns

x_3x_4 \ x_1x_2	00	01	11	10
00	m_0	m_4	m_{12}	m_8
01	m_1	m_5	m_{13}	m_9
11	m_3	m_7	m_{15}	m_{11}
10	m_2	m_6	m_{14}	m_{10}

adjacent
columns

adjacent
rows

Adjacency Rules

		x_1x_2			
		00	01	11	10
x_3	0	m_0	m_2	m_6	m_4
	1	m_1	m_3	m_7	m_5



adjacent
columns

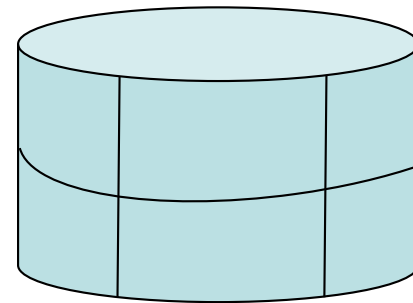

As if the K-map were
drawn on a cylinder

Adjacency Rules

		x_1x_2			
		00	01	11	10
x_3	0	m_0	m_2	m_6	m_4
	1	m_1	m_3	m_7	m_5



adjacent
columns

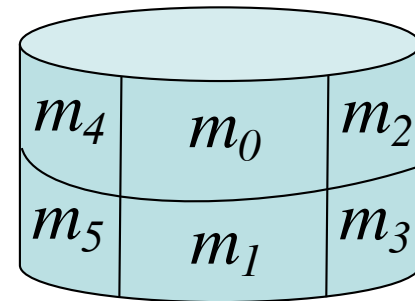

As if the K-map were
drawn on a cylinder

Adjacency Rules

$x_3x_4 \backslash x_1x_2$	00	01	11	10
00	m_0	m_4	m_{12}	m_8
01	m_1	m_5	m_{13}	m_9
11	m_3	m_7	m_{15}	m_{11}
10	m_2	m_6	m_{14}	m_{10}

adjacent
rows

adjacent
columns

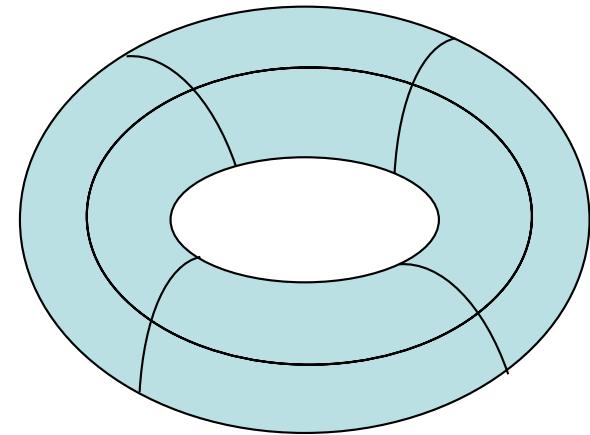

As if the K-map were
drawn on a torus

Adjacency Rules

$x_3x_4 \backslash x_1x_2$	00	01	11	10
00	m_0	m_4	m_{12}	m_8
01	m_1	m_5	m_{13}	m_9
11	m_3	m_7	m_{15}	m_{11}
10	m_2	m_6	m_{14}	m_{10}

adjacent
rows

adjacent
columns

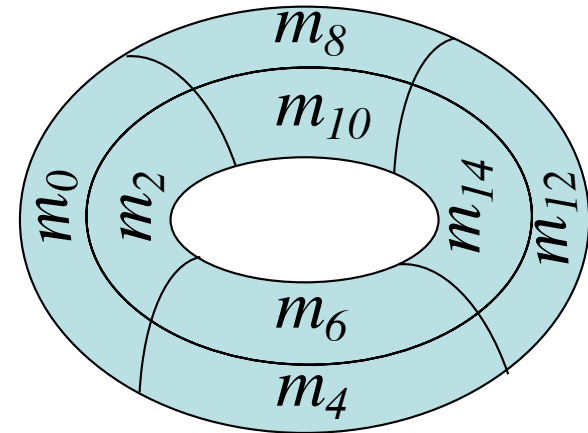

As if the K-map were
drawn on a torus

Gray Code & K-map

x1	x2	x3	x4	
0	0	0	0	m0
0	0	0	1	m1
0	0	1	0	m2
0	0	1	1	m3
<hr/>				
0	1	0	0	m4
0	1	0	1	m5
0	1	1	0	m6
0	1	1	1	m7
<hr/>				
1	0	0	0	m8
1	0	0	1	m9
1	0	1	0	m10
1	0	1	1	m11
<hr/>				
1	1	0	0	m12
1	1	0	1	m13
1	1	1	0	m14
1	1	1	1	m15

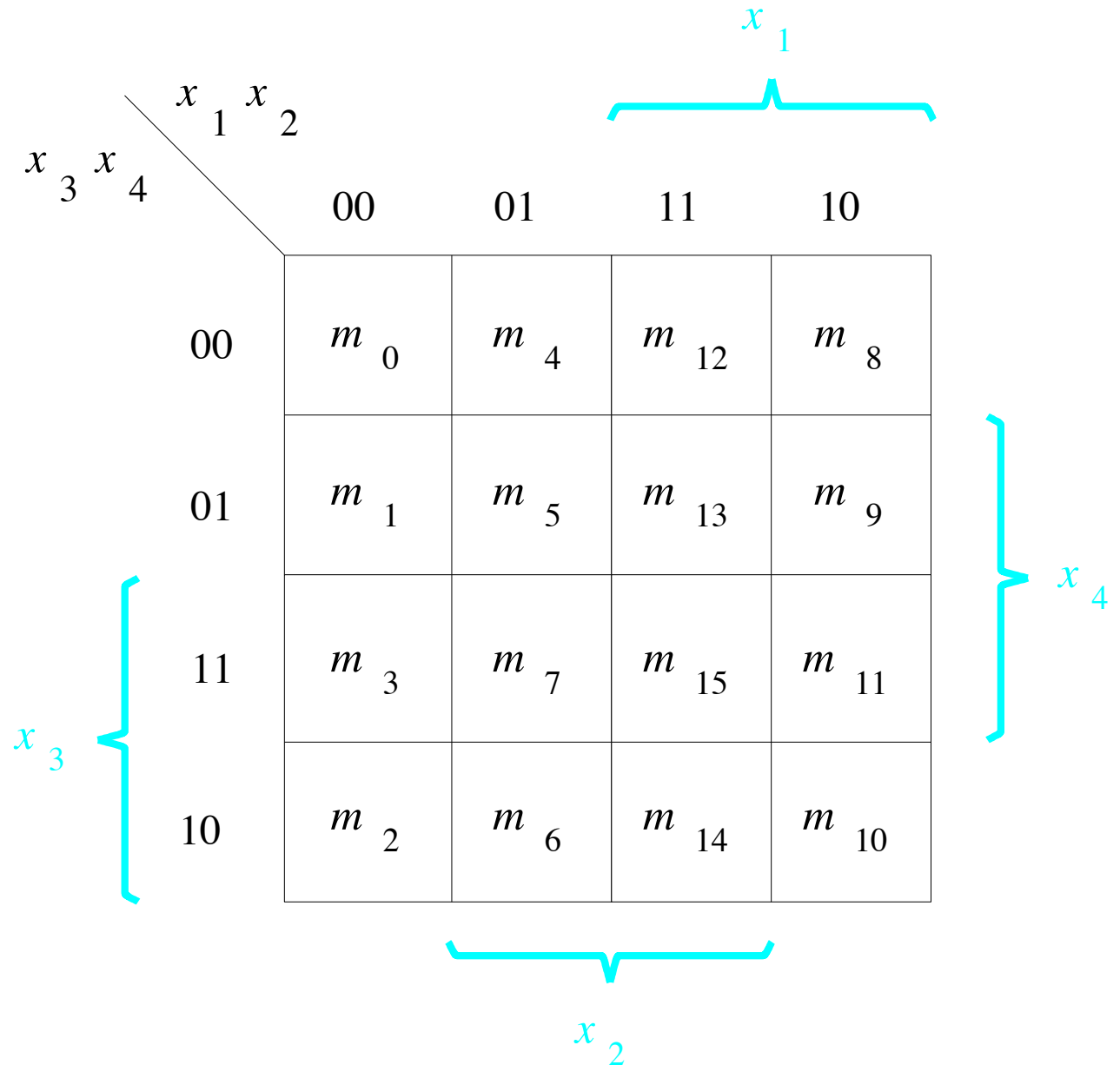

Gray Code & K-map

x1	x2	x3	x4	
0	0	0	0	m0
0	0	0	1	m1
0	0	1	0	m2
0	0	1	1	m3
<hr/>				
0	1	0	0	m4
0	1	0	1	m5
0	1	1	0	m6
0	1	1	1	m7
<hr/>				
1	0	0	0	m8
1	0	0	1	m9
1	0	1	0	m10
1	0	1	1	m11
<hr/>				
1	1	0	0	m12
1	1	0	1	m13
1	1	1	0	m14
1	1	1	1	m15

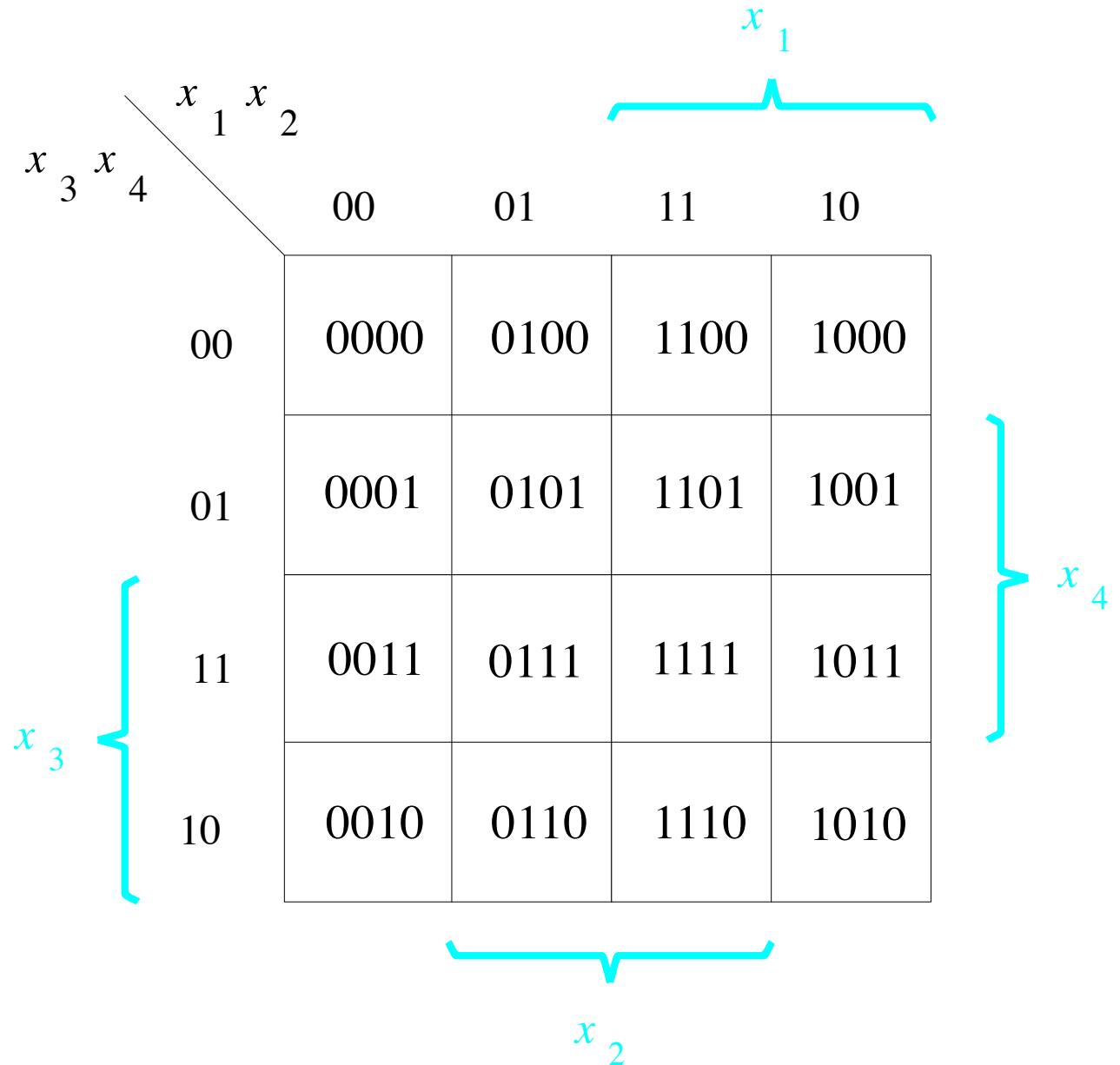

Example of a four-variable Karnaugh map

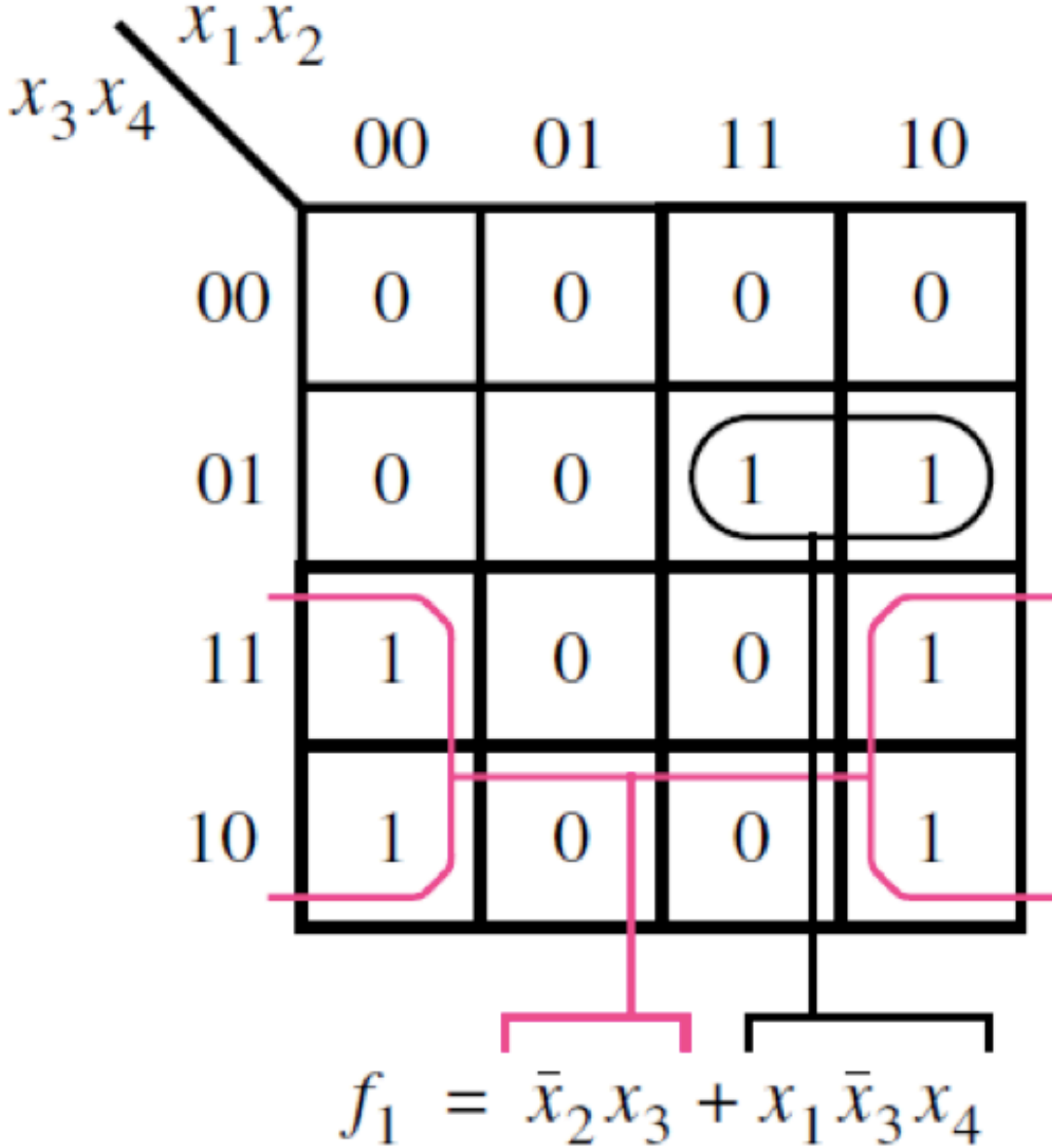

[Figure 2.54 from the textbook]

Example of a four-variable Karnaugh map

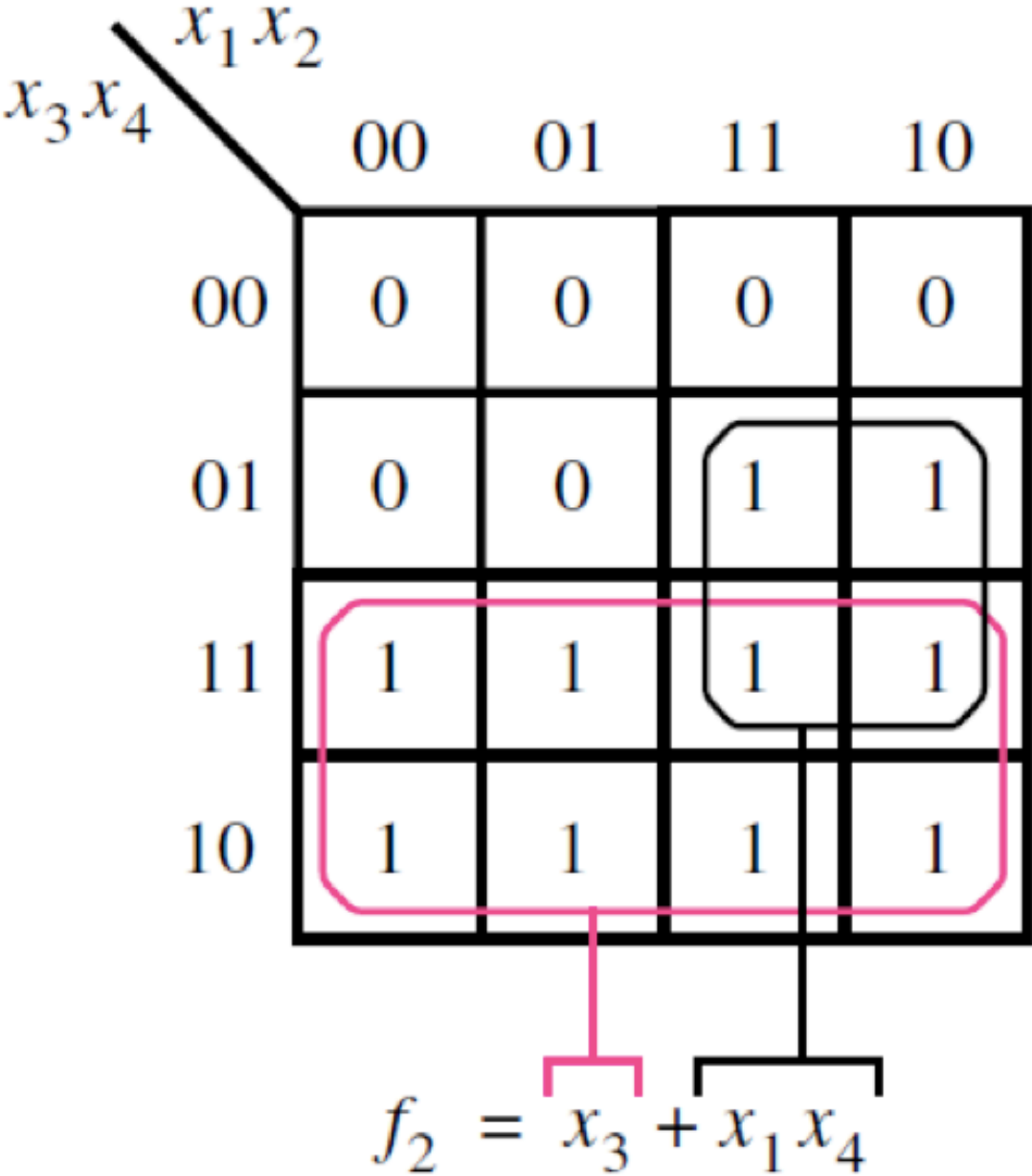

[Figure 2.54 from the textbook]

Strategy For Minimization

Grouping Rules

- **Group “1”s with rectangles**
- **Both sides a power of 2:**
 - **1x1, 1x2, 2x1, 2x2, 1x4, 4x1, 2x4, 4x2, 4x4**
- **Can use the same minterm more than once**
- **Can wrap around the edges of the map**
- **Some rules in selecting groups:**
 - **Try to use as few groups as possible to cover all “1”s.**
 - **For each group, try to make it as large as you can (i.e., if you can use a 2x2, don’t use a 2x1 even if that is enough).**

Terminology

Literal: a variable, complemented or uncomplemented

Some Examples:

- \bar{X}_1
- X_2

Terminology

- **Implicant: product term that indicates the input combinations for which the function output is 1**

- **Example**

- \bar{x}_1 - indicates that $\bar{x}_1\bar{x}_2$ and \bar{x}_1x_2 yield output of 1

		x_1	
		0	1
x_2	0	1	0
	1	1	0

Terminology

- **Prime Implicant**

- Implicant that cannot be combined into another implicant with fewer literals

- **Some Examples**

$x_3 \backslash x_1 x_2$	00	01	11	10
0	0	1	1	1
1	1	1	1	0

Not prime

$x_3 \backslash x_1 x_2$	00	01	11	10
0	0	1	1	1
1	1	1	1	0

Prime

Terminology

- **Essential Prime Implicant**
 - Prime implicant that includes a minterm not covered by any other prime implicant
 - **Some Examples**

		$x_1 x_2$			
		00	01	11	10
x_3	0	0	1	1	1
	1	1	1	0	0

The Karnaugh map shows the following prime implicants highlighted:

- Red boxes (Essential Prime Implicants):** x_3 (covering minterms 001 and 101), x_1 (covering minterms 010 and 110), and x_2 (covering minterms 011 and 101).
- Blue box (Non-essential Prime Implicant):** $x_1 x_2$ (covering minterms 010 and 011).

Terminology

- **Cover**

- **Collection of implicants that account for all possible input valuations where output is 1**

- **Ex. $x_1' x_2 x_3 + x_1 x_2 x_3' + x_1 x_2' x_3'$**

- **Ex. $x_1' x_2 x_3 + x_1 x_3'$**

		$x_1 x_2$			
		00	01	11	10
x_3	0	0	0	1	1
	1	0	1	0	0

Example

- Give the Number of
 - Implicants?
 - Prime Implicants?
 - Essential Prime Implicants?

x_3 \ $x_1 x_2$	00	01	11	10
0	1	1	0	0
1	1	1	1	0

Why concerned with minimization?

- **Simplified function**
- **Reduce the cost of the circuit**
 - **Cost: Gates + Inputs**
 - **Transistors**

Three-variable function $f(x_1, x_2, x_3) = \sum m(0, 1, 2, 3, 7)$

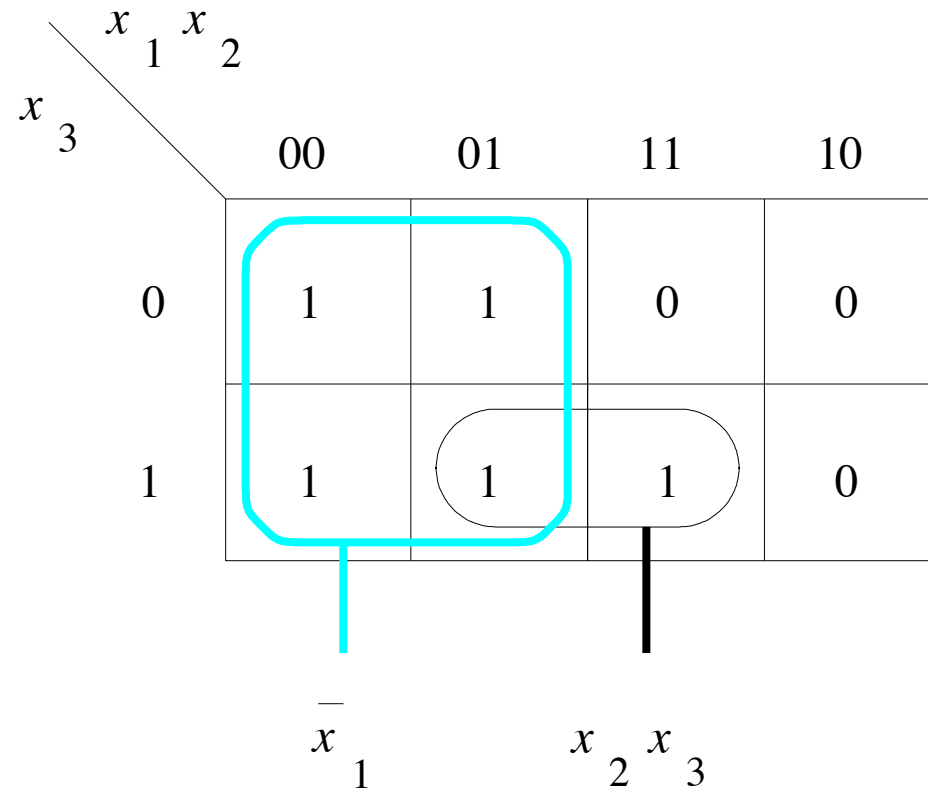

Example

$x_3 x_4$		$x_1 x_2$			
		00	01	11	10
00	1	1			
01		1	1		
11			1	1	
10	1			1	

Example

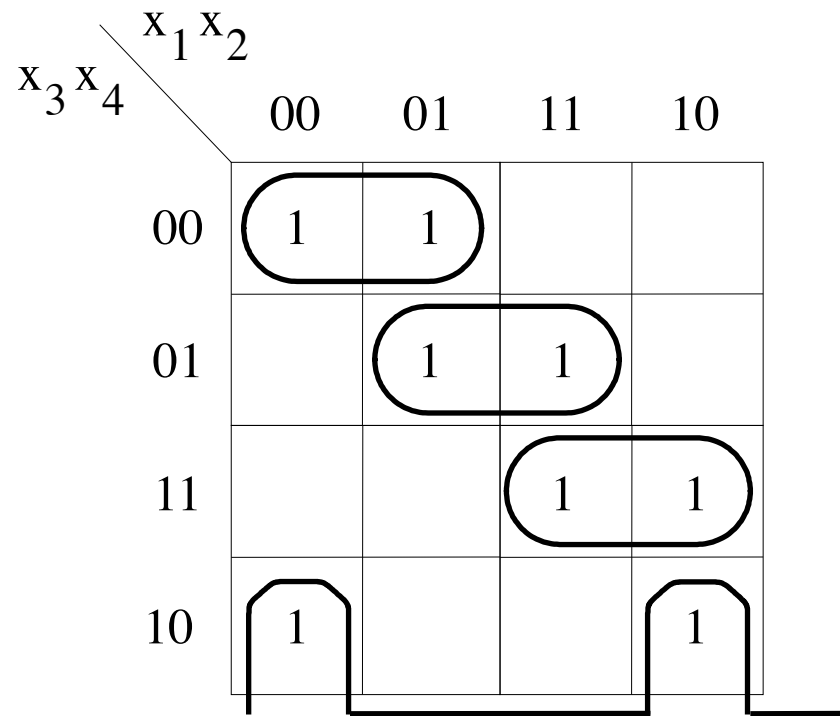

Example

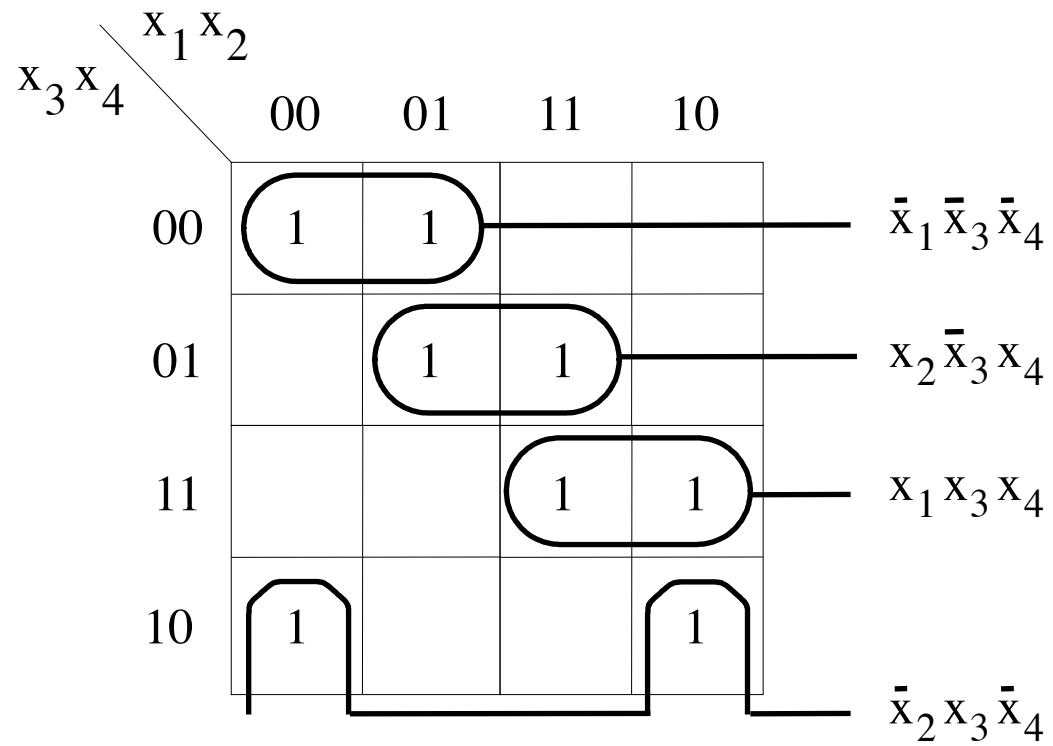

Example

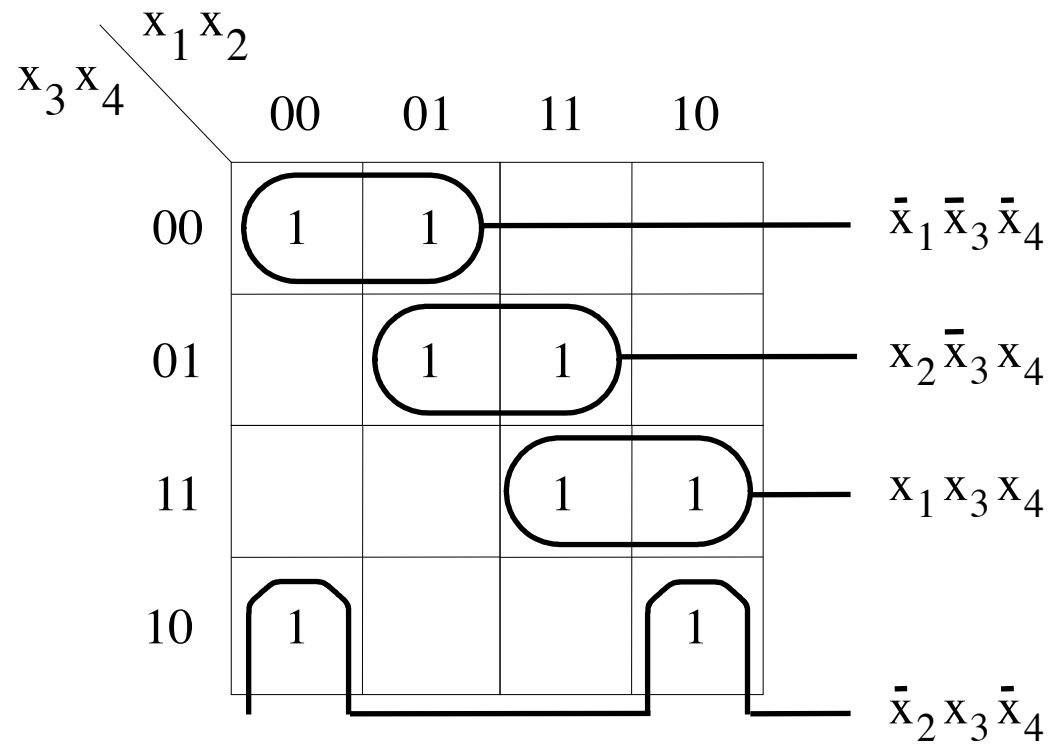

$$f = \bar{x}_1 \bar{x}_3 \bar{x}_4 + x_2 \bar{x}_3 x_4 + x_1 x_3 x_4 + \bar{x}_2 x_3 \bar{x}_4$$

Example: Another Solution

$x_3 x_4$		$x_1 x_2$			
		00	01	11	10
00	1	1			
01		1	1		
11			1	1	
10	1			1	

Example: Another Solution

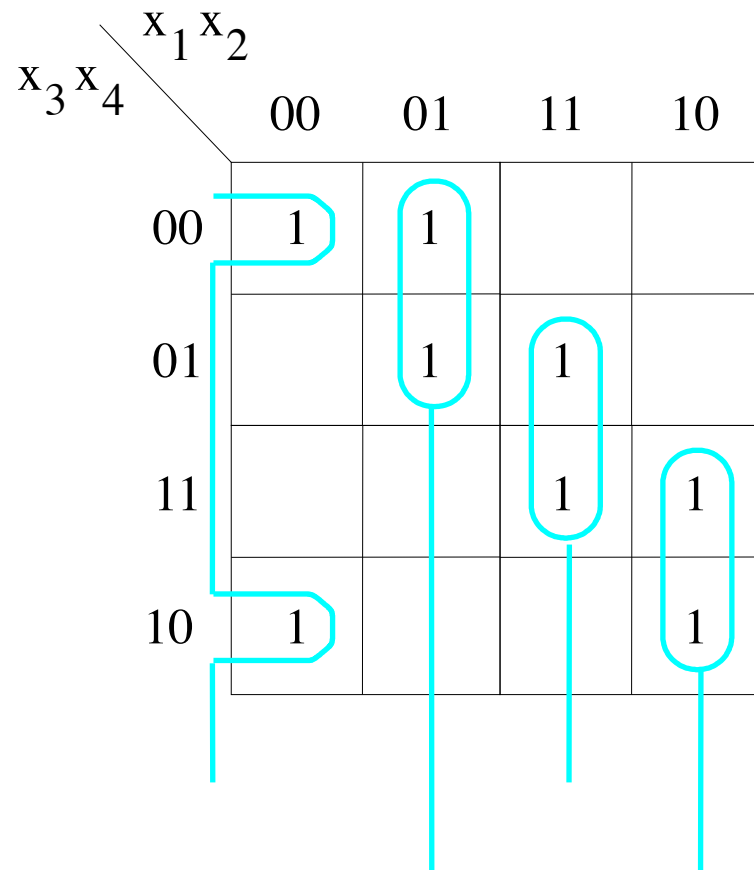

Example: Another Solution

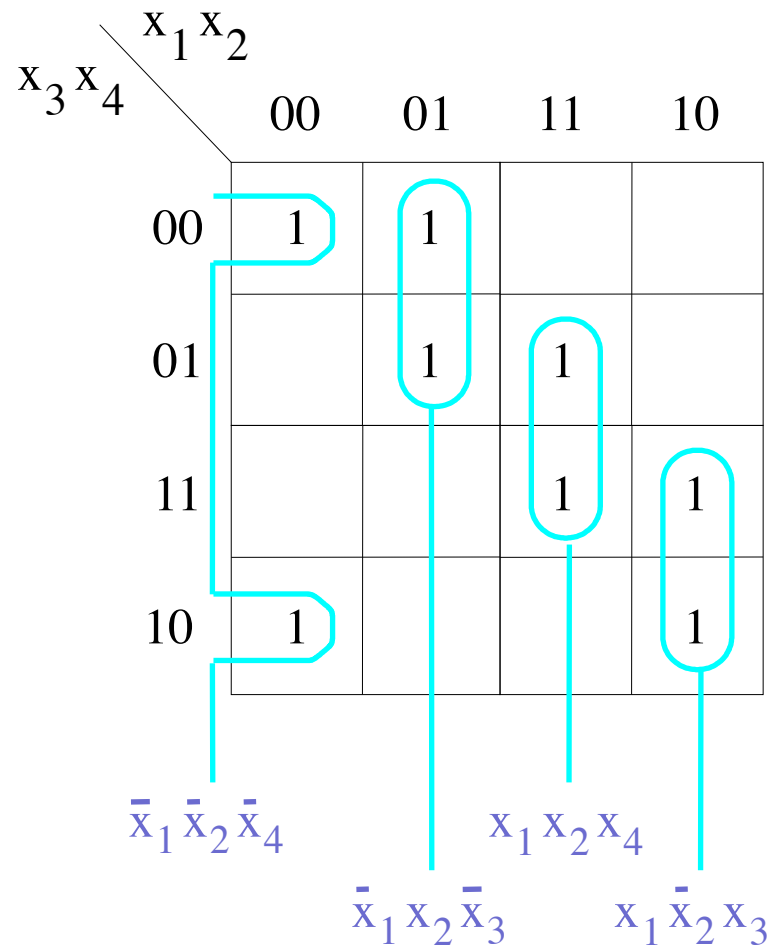

Example: Another Solution

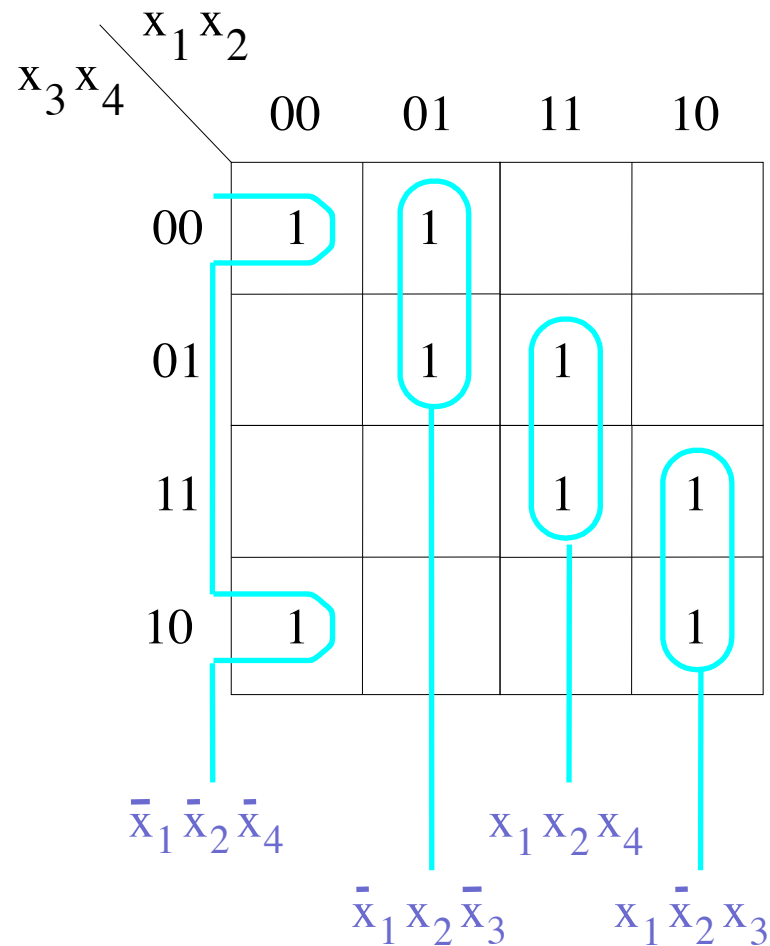

$$f = \bar{x}_1 \bar{x}_2 \bar{x}_4 + \bar{x}_1 x_2 \bar{x}_3 + x_1 x_2 x_4 + x_1 \bar{x}_2 x_3$$

Example: Both Are Valid Solutions

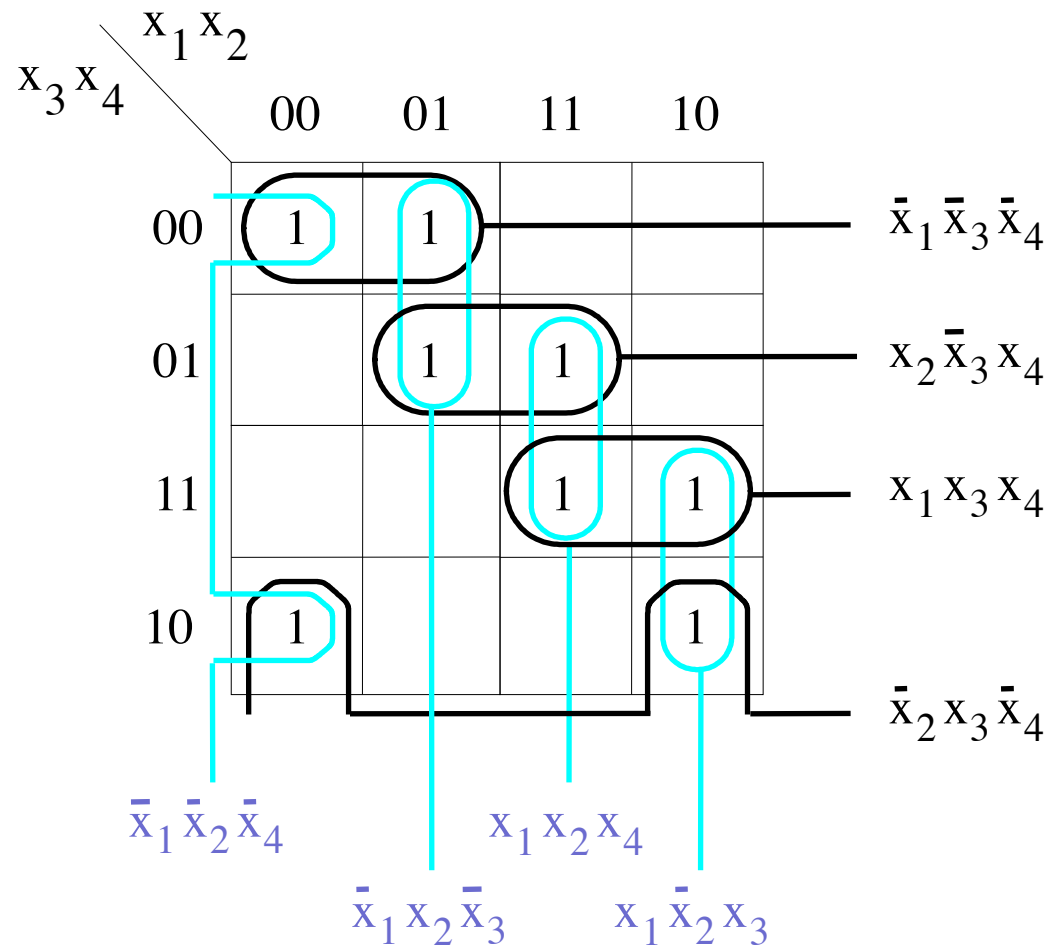

Example: Both Are Valid Solutions

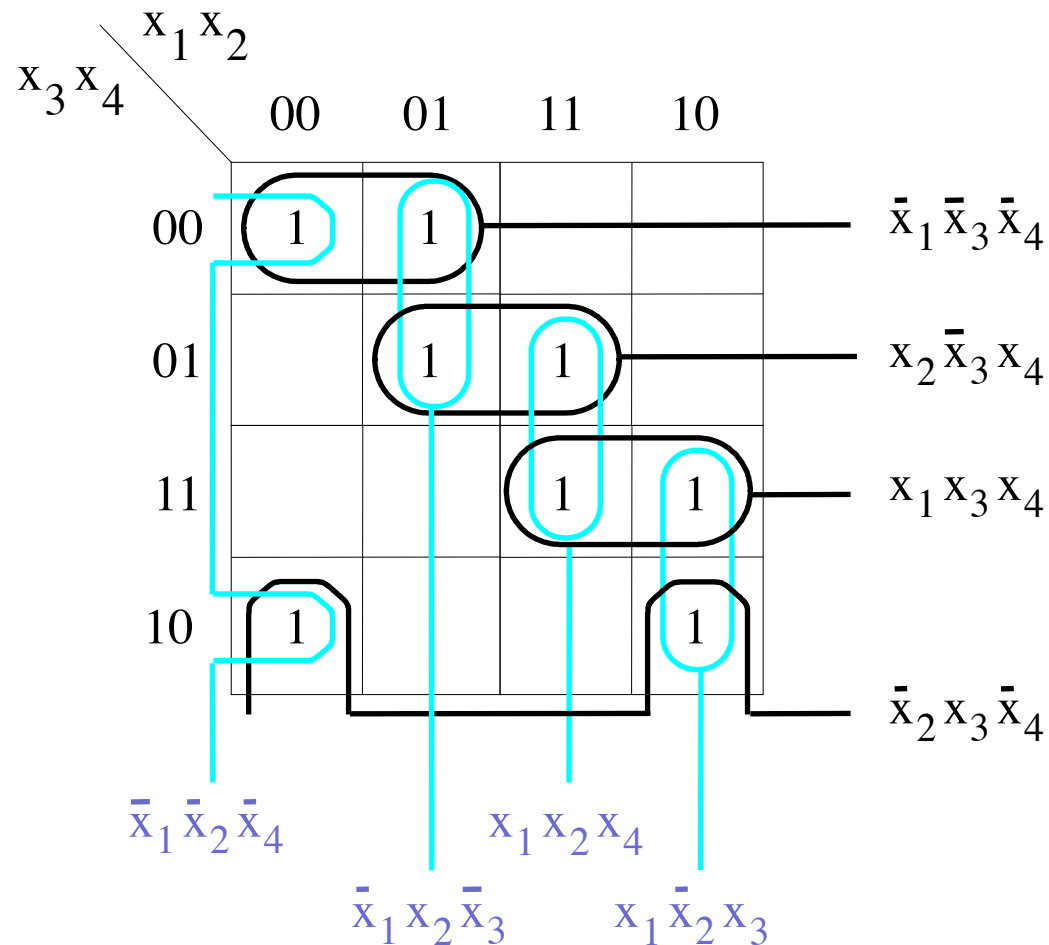

$$f = \bar{x}_1 \bar{x}_3 \bar{x}_4 + x_2 \bar{x}_3 x_4 + x_1 x_3 x_4 + \bar{x}_2 x_3 \bar{x}_4$$

$$f = \bar{x}_1 \bar{x}_2 \bar{x}_4 + \bar{x}_1 x_2 \bar{x}_3 + x_1 x_2 x_4 + x_1 \bar{x}_2 x_3$$

Minimization of Product-of-Sums Forms

Do You Still Remember This Boolean Algebra Theorem?

14a. $x \cdot y + x \cdot \bar{y} = x$

Combining

14b. $(x + y) \cdot (x + \bar{y}) = x$

Let's prove 14.b

x	y	$(\mathbf{x} + \mathbf{y}) \bullet (\mathbf{x} + \overline{\mathbf{y}}) = \mathbf{x}$
0	0	
0	1	
1	0	
1	1	

Let's prove 14.b

x	y	$(\mathbf{x} + \mathbf{y}) \bullet (\mathbf{x} + \overline{\mathbf{y}}) = \mathbf{x}$
0	0	0
0	1	1
1	0	1
1	1	1

Let's prove 14.b

x	y	$(\mathbf{x} + \mathbf{y}) \cdot (\mathbf{x} + \overline{\mathbf{y}}) = \mathbf{x}$
0	0	0 1
0	1	1 0
1	0	1 1
1	1	1 1

Let's prove 14.b

x	y	$(\mathbf{x} + \mathbf{y}) \bullet (\mathbf{x} + \overline{\mathbf{y}}) = \mathbf{x}$			
0	0	0	0	1	
0	1	1	0	0	
1	0	1	1	1	
1	1	1	1	1	

Let's prove 14.b

x	y	$(x + y) \cdot (x + \bar{y}) = x$				
0	0	0	0	1	0	
0	1	1	0	0	0	
1	0	1	1	1	1	
1	1	1	1	1	1	

Let's prove 14.b

x	y	$(x + y) \cdot (x + \bar{y}) = x$				
0	0	0	0	1	0	
0	1	1	0	0	0	
1	0	1	1	1	1	
1	1	1	1	1	1	

They are equal.

Grouping Example

		x_1	
	x_2		
		0	1
0		0	1
1		1	1

M_0

		x_1	
	x_2		
		0	1
0		1	0
1		1	1

M_2

Grouping Example

	x_1	0	1
x_2			
0		0	1
1		1	1

M_0

*

	x_1	0	1
x_2			
0		1	0
1		1	1

M_2

=

	x_1	0	1
x_2			
0		0	0
1		1	1

$M_0 * M_2$

Grouping Example

	x_1	0	1
x_2	0	0	1
	1	1	1

M_0

*

	x_1	0	1
x_2	0	1	0
	1	1	1

M_2

=

	x_1	0	1
x_2	0	0	0
	1	1	1

$M_0 * M_2$

Grouping Example

	x_1	0	1
x_2	0	0	1
	1	1	1

M_0

*

	x_1	0	1
x_2	0	1	0
	1	1	1

M_2

=

	x_1	0	1
x_2	0	0	0
	1	1	1

$M_0 * M_2$

Grouping Example

	x_1	0	1
x_2	0	0	1
	1	1	1

M_0

$(x_1 + x_2)$

	x_1	0	1
x_2	0	1	0
	1	1	1

M_2

$(\bar{x}_1 + x_2)$

*

*

*

=

=

=

	x_1	0	1
x_2	0	0	0
	1	1	1

$M_0 * M_2$

x_2

Property 14b (Combining)

Expressions with three variables (for three-variable K-maps)

Groupings and Expressions

		x_1x_2			
		00	01	11	10
x_3	0	0	1	1	1
	1	1	1	1	1

$$(x_1 + x_2 + x_3)$$

		x_1x_2			
		00	01	11	10
x_3	0	1	0	1	1
	1	1	1	1	1

$$(x_1 + \bar{x}_2 + x_3)$$

		x_1x_2			
		00	01	11	10
x_3	0	1	1	0	1
	1	1	1	1	1

$$(\bar{x}_1 + \bar{x}_2 + x_3)$$

		x_1x_2			
		00	01	11	10
x_3	0	1	1	1	0
	1	1	1	1	1

$$(\bar{x}_1 + x_2 + x_3)$$

Groupings and Expressions

		x_1x_2			
		00	01	11	10
x_3	0	1	1	1	1
	1	0	1	1	1

$$(x_1 + x_2 + \bar{x}_3)$$

		x_1x_2			
		00	01	11	10
x_3	0	1	1	1	1
	1	1	0	1	1

$$(x_1 + \bar{x}_2 + \bar{x}_3)$$

		x_1x_2			
		00	01	11	10
x_3	0	1	1	1	1
	1	1	1	0	1

$$(\bar{x}_1 + \bar{x}_2 + \bar{x}_3)$$

		x_1x_2			
		00	01	11	10
x_3	0	1	1	1	1
	1	1	1	1	0

$$(\bar{x}_1 + x_2 + \bar{x}_3)$$

**Expressions with two variables
(for three-variable K-maps)**

Groupings and Expressions

		x_1x_2			
		00	01	11	10
x_3	0	0	1	1	1
	1	0	1	1	1

$$(x_1 + x_2)$$

		x_1x_2			
		00	01	11	10
x_3	0	1	0	1	1
	1	1	0	1	1

$$(x_1 + \bar{x}_2)$$

		x_1x_2			
		00	01	11	10
x_3	0	1	1	0	1
	1	1	1	0	1

$$(\bar{x}_1 + \bar{x}_2)$$

		x_1x_2			
		00	01	11	10
x_3	0	1	1	1	0
	1	1	1	1	0

$$(\bar{x}_1 + x_2)$$

Groupings and Expressions

		x_1x_2			
		00	01	11	10
x_3	0	0	0	1	1
	1	1	1	1	1

$$(x_1 + x_3)$$

		x_1x_2			
		00	01	11	10
x_3	0	1	0	0	1
	1	1	1	1	1

$$(\overline{x_2} + x_3)$$

		x_1x_2			
		00	01	11	10
x_3	0	1	1	0	0
	1	1	1	1	1

$$(\overline{x_1} + x_3)$$

		x_1x_2			
		00	01	11	10
x_3	0	0	1	1	0
	1	1	1	1	1

$$(x_2 + x_3)$$

Groupings and Expressions

		x_1x_2			
		00	01	11	10
x_3	0	1	1	1	1
	1	0	0	1	1

$$(\overline{x_1} + \overline{x_3})$$

		x_1x_2			
		00	01	11	10
x_3	0	1	1	1	1
	1	1	0	0	1

$$(\overline{x_2} + \overline{x_3})$$

		x_1x_2			
		00	01	11	10
x_3	0	1	1	1	1
	1	1	1	0	0

$$(\overline{x_1} + \overline{x_3})$$

		x_1x_2			
		00	01	11	10
x_3	0	1	1	1	1
	1	0	1	1	0

$$(\overline{x_2} + \overline{x_3})$$

Expressions with one variable (for three-variable K-maps)

Groupings and Expressions

		x_1x_2			
		00	01	11	10
x_3	0	0	0	1	1
	1	0	0	1	1

(x_1)

		x_1x_2			
		00	01	11	10
x_3	0	1	0	0	1
	1	1	0	0	1

(\bar{x}_2)

		x_1x_2			
		00	01	11	10
x_3	0	1	1	0	0
	1	1	1	0	0

(\bar{x}_1)

		x_1x_2			
		00	01	11	10
x_3	0	0	1	1	0
	1	0	1	1	0

(x_2)

Groupings and Expressions

		x_1x_2			
		00	01	11	10
x_3	0	0	0	0	0
	1	1	1	1	1

(x_3)

		x_1x_2			
		00	01	11	10
x_3	0	1	1	1	1
	1	0	0	0	0

(\bar{x}_3)

**Expressions with zero variables
(for three-variable K-maps)**

Groupings and Expressions

		x_1x_2			
		00	01	11	10
x_3	0	0	0	0	0
	1	0	0	0	0

0

		x_1x_2			
		00	01	11	10
x_3	0	1	1	1	1
	1	1	1	1	1

1

Some Examples

POS minimization of $f(x_1, x_2, x_3) = \prod M(4, 5, 6)$

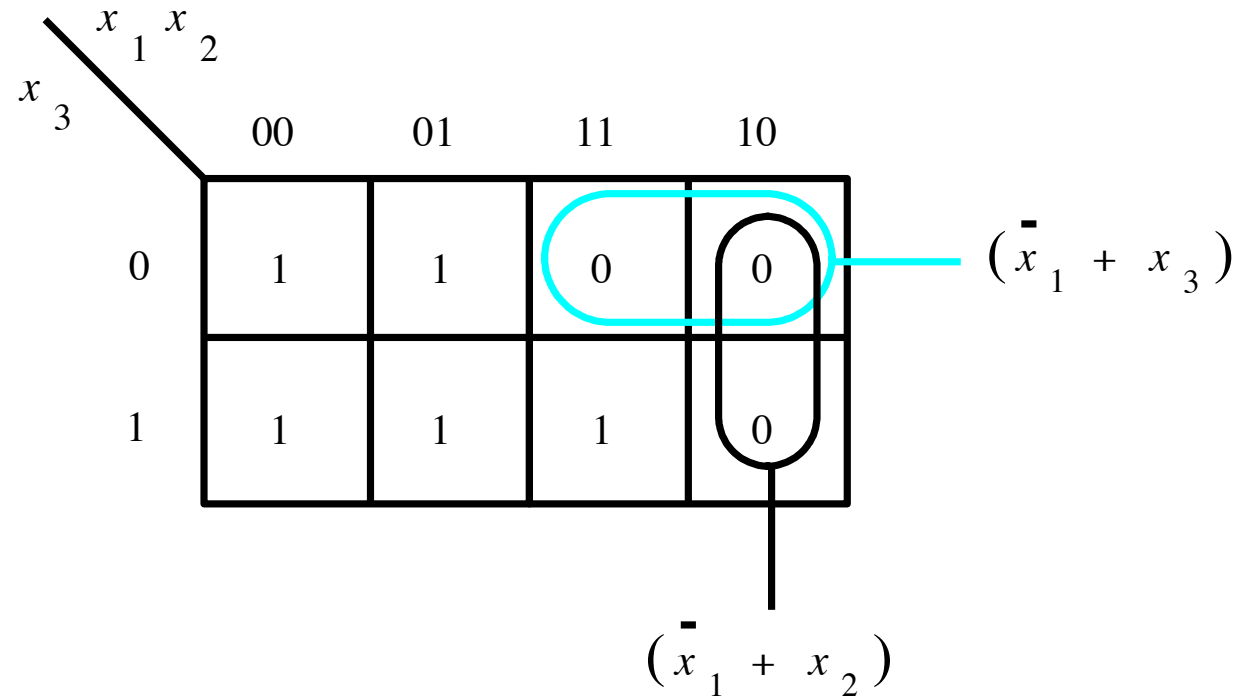

POS minimization of $f(x_1, \dots, x_4) = \prod M(0, 1, 4, 8, 9, 12, 15)$

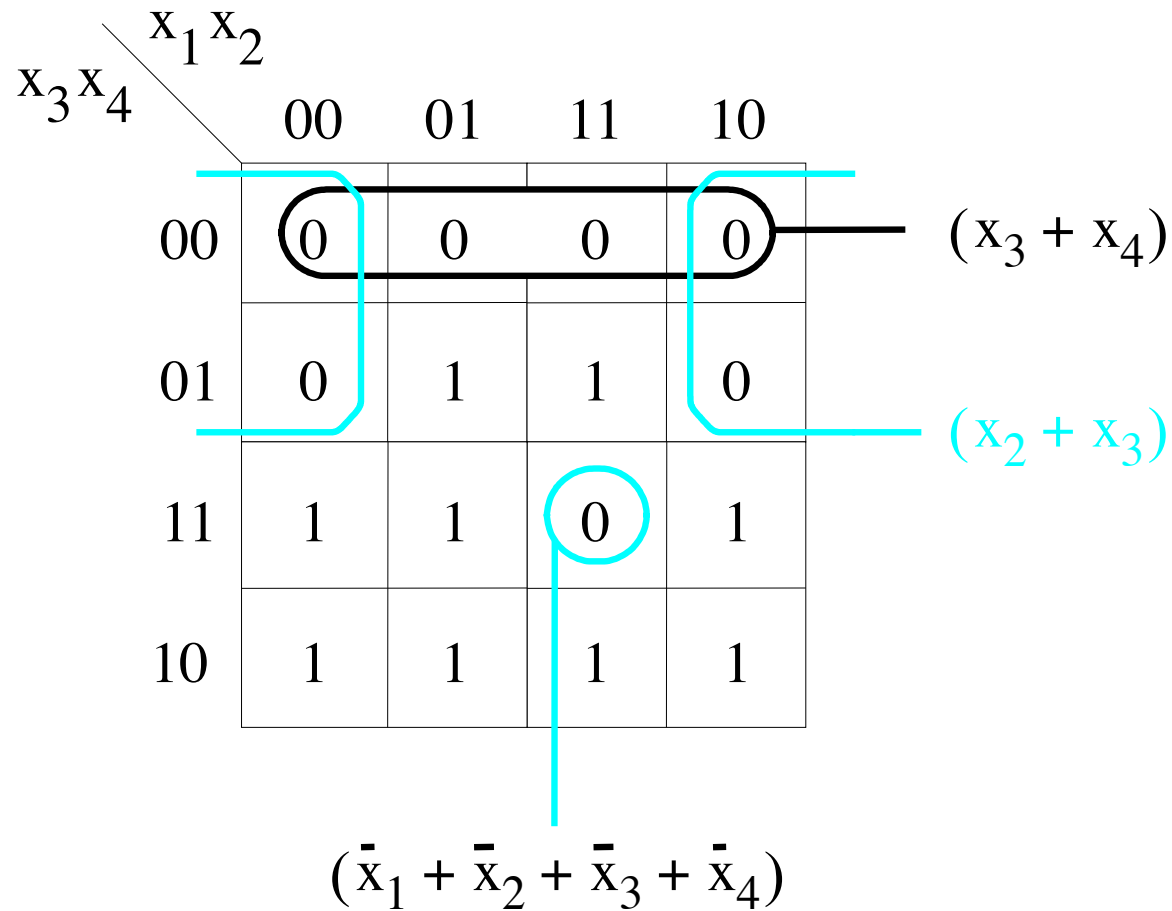

Questions?

THE END