

Costs of Generating Electrical Energy

1.0 Overview

The short-run costs of electrical energy generation can be divided into two broad areas: fixed and variable costs. These costs are illustrated in Fig. 1 below.

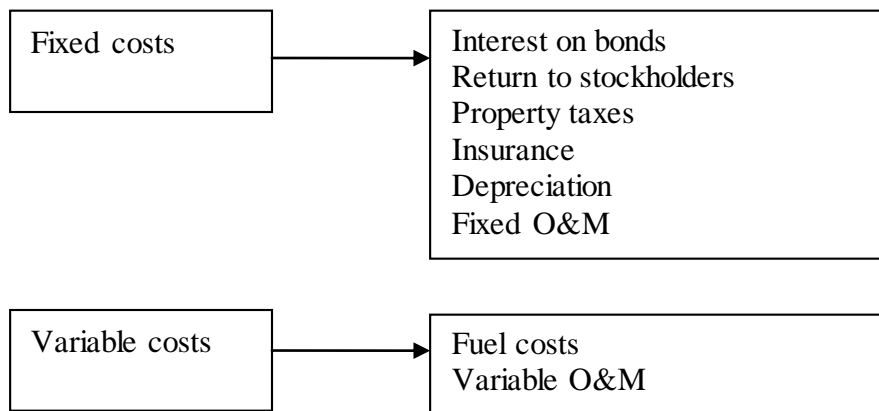

Fig. 1

Typical values of these costs are given in the following Table 1 [1]. Some notes of interest follow:

- The “overnight cost” is the cost of constructing the plant, in \$/kW, if the plant could be constructed in a single day.
- The “variable O&M” is in mills/kWhr (a mill is 0.1¢). These values represent mainly maintenance costs. They do not include fuel costs.
- Fuel costs are computed through the heat rate. We will discuss this calculation in depth.
- The heat rate values given are average values.
- The table was developed in 2011, and so some costs have changed quite a bit since then, particularly solar.

Table 1

Technology	Size (MW)	Lead Time (Years)	Overnight Cost in 2009 (2008 US\$/kW)	Variable O&M (2008 mills/kWh)	Fixed O&M (2008 US\$/kW)	Heat Rate in 2009 (Btu/kWhr)	Emissions (lb/MWhr)				
							CO ₂	SO ₂	NO _x	Particulate	Hg
Scrubbed pulverized supercritical coal new	600	4	2,223	4.69	28.15	9,200	1,681	0.7007	0.579	0.107	9.45E-06
Integrated coal-gasification combined cycle (IGCC)	550	4	2,569	2.99	39.53	8,765	1,459	0.0942	0.406	0.053	4.24E-06
IGCC with carbon sequestration	380	4	3,776	4.54	47.15	10,781	154	0.0751	0.366	0.056	4.48E-06
Conventional gas/oil combined cycle	250	3	984	2.11	12.76	7,196	727.65	Negligible	0.203	Negligible	Negligible
Advanced gas/oil combined cycle	400	3	968	2.04	11.96	6,752	783	Negligible	0.06	Negligible	Negligible
Adv gas combined cycle with carbon sequestration	400	3	1,932	3.01	20.35	8,613	85.8	Negligible	0.066	Negligible	Negligible
Conventional combustion turbine	160	2	685	3.65	12.38	10,788	266.8	None	0.117	Negligible	None
Advanced combustion turbine	230	2	648	3.24	10.77	9,289	217.7	None	0.117	Negligible	None
Fuel cells	10	3	5,478	49.00	5.78	7,930	None	None	None	None	None
Advanced nuclear	1,350	6	3,820	0.51	92.04	10,488	None	None	None	None	None
Biomass	80	4	3,849	6.86	65.89	9,451	Negligible	0.07	1.575	0.27	Unknown
Geothermal	50	4	1,749	0.00	168.33	32,969	Negligible	Negligible	Unknown	Unknown	Unknown
Landfill gas	30	3	2,599	0.01	116.80	13,648	Unknown	Unknown	1.833	0.388	Unknown
Conventional hydropower	500	4	2,291	2.49	13.93	N/A	None	None	None	None	None
Wind	50	3	1,966	0.00	30.98	N/A	None	None	None	None	None
Wind offshore	100	4	3,937	0.00	86.92	N/A	None	None	None	None	None
Concentrated solar power	100	3	5,132	0.00	58.05	N/A	None	None	None	None	None
Photovoltaic	5	2	6,171	0.00	11.94	N/A	None	None	None	None	None

We focus on operating costs in these notes. Our goal is to characterize the relation between the cost and the amount of electric energy out of the power plant.

2.0 Fuels

Fuel costs dominate the operating costs necessary to produce electrical energy (MW) from the plant, sometimes called production costs. We begin with nuclear. Enriched uranium (3.5% U-235) in a light water reactor has an energy content of 960MWhr/kg [2], or multiplying by 3.41 MBTU/MWhr, we get 3274MBTU/kg. The total cost of bringing uranium to the fuel rods of a nuclear power plant, considering mining, transportation, conversion¹, enrichment, and fabrication, has been estimated to be \$2770/kg [3]. Therefore, the cost per MBTU of nuclear fuel is about $\$2770/\text{kg} / 3274\text{MBTU}/\text{kg} = \$0.85/\text{MBTU}^2$.

To give some idea of the difference between costs of different fossil fuels, some typical average costs of fuel are given in the Table 2 for coal, petroleum, and natural gas. One should note in particular

- The difference between lowest and highest average price over this 20-year period for coal, petroleum, and natural gas are by factors of 1.72, 7.27, and

¹ “Conversion” here does not mean to electric energy. Rather, uranium concentrates are purified and *converted* to uranium hexafluoride (UF₆) or feed (F), the feed for uranium enrichment plants. See EPRI Report 1020659, “Parametric Study of Front-End Nuclear Fuel Cycle Costs Using Reprocessed Uranium,” January 2010.

² This is a very low fuel cost! However, it is balanced by a relatively high investment (overnight) cost – see Table 1.

4.60, respectively, so coal has had more stable price variability than petroleum and natural gas.

- During 2011, coal is \$2.40/MBTU, petroleum \$20.11/MBTU, and natural gas \$4.71/MBTU, so coal is clearly a more economically attractive fuel for producing electricity (gas may begin to look much better if a CO2 cap-n-trade system is begun).

Table 2: Receipts, Average Cost, and Quality of Fossil Fuels for the Electric Power Industry, 1991 through 2011, obtained from [4]

Period	Coal [1]			Petroleum [2]			Natural Gas [3]		All Fossil Fuels		
	Receipts (Billion BTU)	Average Cost (\$ per 10 6 Btu) (dollars/ton)	Avg. Sulfur Percent by Weight	Receipts (billion BTU)	Average Cost (\$ per 10 6 Btu) (dollars/barrel)	Avg. Sulfur Percent by Weight	Receipts (Billion BTUs)	Average Cost (cents/ 10 6 Btu)	Average Cost (cents/ 10 6 Btu)		
1992		1.41	29.36	1.29				2.32	1.5		
1993		1.38	28.58	1.18				2.56	1.59		
1994		1.35	28.03	1.17				2.23	1.52		
1995	16,946,807	1.32	27.01	1.08	532,564	2.68	16.93	0.9	3,081,506	1.98	1.45
1996	17,707,127	1.29	26.45	1.10	673,845	3.16	19.95	1	2,649,028	2.64	1.52
1997	18,095,870	1.27	26.16	1.11	748,634	2.88	18.3	1.1	2,817,639	2.76	1.52
1998	19,036,478	1.25	25.64	1.06	1,048,098	2.14	13.55	1.1	2,985,866	2.38	1.44
1999	18,460,617	1.22	24.72	1.01	833,706	2.53	16.03	1.1	2,862,084	2.57	1.44
2000	15,987,811	1.2	24.28	0.93	633,609	4.45	28.24	1	2,681,659	4.3	1.74
2001	15,285,607	1.23	24.68	0.89	726,135	3.92	24.86	1.1	2,209,089	4.49	1.73
2002[4]	17,981,987	1.25	25.52	0.94	623,354	3.87	24.45	0.9	5,749,844	3.56	1.86
2003[5]	19,989,772	1.28	26.00	0.97	980,983	4.94	31.02	0.83	5,663,023	5.39	2.28
2004	20,188,633	1.36	27.42	0.97	958,046	5	31.58	0.88	5,890,750	5.96	2.48
2005	20,647,307	1.54	31.20 ¹	0.98	986,258	7.59	47.61	0.77	6,356,868	8.21	3.25
2006	21,735,101	1.69	34.09	0.97	406,869	8.68	54.35	0.73	6,855,680	6.94	3.02
2007	21,152,358	1.77	35.48	0.96	375,260	9.59	59.93	0.71	7,396,233	7.11	3.23
2008	21,280,258	2.07	41.14	0.97	375,684	15.52	95.38	0.61	8,089,467	9.01	4.12
2009	19,437,966	2.21	43.74	1.01	330,043	10.25	62.47	0.54	8,319,329	4.74	3.04
2010	19,289,661	2.27	44.64	1.16	275,058	14.02	84.80	0.51	8,867,396	5.09	3.26
2011	18,675,843	2.39	46.65	1.19	216,752	19.94	119.54	0.6	9,250,652	4.72	3.29
2012	16,459,166	2.40	46.58	1.26	151,815	21.82	129.99	0.51	10,872,094	3.40	2.90

[1] Anthracite, bituminous coal, subbituminous coal, lignite, waste coal, and synthetic coal.
[2] Distillate fuel oil (all diesel and No. 1, No. 2, and No. 4 fuel oils), residual fuel oil (No. 5 and No. 6 fuel oils and bunker C fuel oil), jet fuel, kerosene, petroleum coke (converted to liquid petroleum, see Technical Notes for conversion methodology), and waste oil.
[3] Natural gas, including a small amount of supplemental gaseous fuels that cannot be identified separately. Natural gas values for 2001 forward do not include blast furnace gas or other gas.
[4] Beginning in 2002, data from the Form EIA-423, "Monthly Cost and Quality of Fuels for Electric Plants Report" for independent power producers and combined heat and power producers are included in this data dissemination. Prior to 2002, these data were not collected; the data for 2001 and previous years include only data collected from electric utilities via the FERC Form 423.
[5] For 2003 only, estimates were developed for missing or incomplete data from some facilities reporting on the FERC Form 423. This was not done for earlier years. Therefore, 2003 data cannot be directly compared to previous years' data. Additional information regarding the estimation procedures that were used is provided in the Technical Notes.

R = Revised.

Notes: Totals may not equal sum of components because of independent rounding. Receipts data for regulated utilities are compiled by EIA from data collected by the Federal Energy Regulatory Commission (FERC) on the FERC Form 423. These data are collected by FERC for regulatory rather than statistical and publication purposes. The FERC Form 423 data published by EIA have been reviewed for consistency between volumes and prices and for their consistency over time. Nonutility data include fuel delivered to electric generating plants with a total fossil-fueled nameplate generating capacity of 50 or more megawatts; utility data include fuel delivered to plants whose total fossil-fueled steam turbine electric generating capacity and/or combined-cycle (gas turbine with associated steam turbine) generating capacity is 50 or more megawatts. Mcf = thousand cubic feet. Monetary values are expressed in nominal terms.

Sources: Energy Information Administration, Form EIA-423, "Monthly Cost and Quality of Fuels for Electric Plants Report;" Federal Energy Regulatory Commission, FERC Form 423, "Monthly Report of Cost and Quality of Fuels for Electric Plants."

Despite the high price of natural gas as a fuel relative to coal, the 2000-2009 time period saw new combined cycle gas-fired plants far outpace new coal-fired plants, with gas accounting for over 85% of new capacity in this time period [5] (of the remaining, 14% was wind). The reason for this has been that gas-fired combined cycle plants have low capital costs, high fuel efficiency, short construction lead times, and low emissions.

This trend has been ongoing for some time, as observed in Fig. 2 [6], where the sharply rising curve from 1990 onwards is gas consumption for electric.

24. U.S. Natural Gas Consumption by Sector, 1949-2011

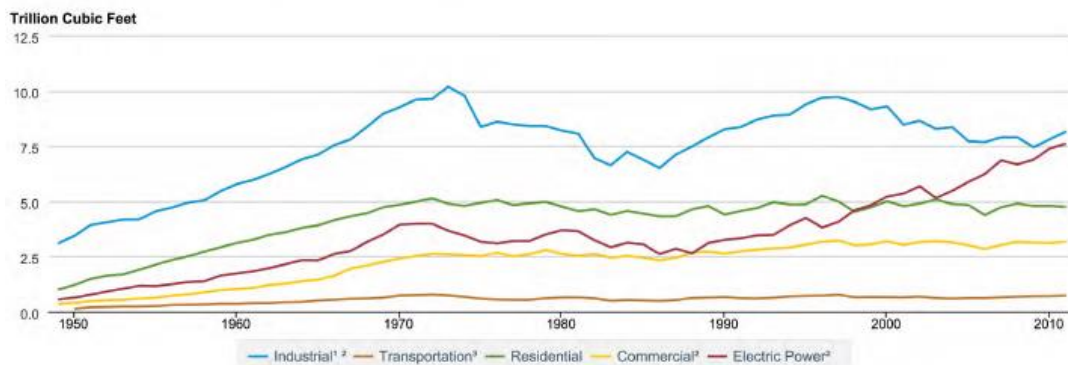

U.S. Energy Information Administration, *Annual Energy Review*, Table 6.5.

¹ Lease and plant fuel, and other industrial.

² The commercial and industrial sectors include combined-heat-and-power plants and a small number of electricity-only plants, whereas the Electric Power sector is electricity-only and combined-heat-and-power plants whose primary business is to sell electricity, or electricity and heat, to the public.

³ Natural gas consumed in the operation of pipelines (primarily in compressors), and as fuel in the delivery of natural gas to consumers; plus a small quantity used as vehicle fuel.

Natural gas consumption by the electric power sector rose 188 percent from 1988 to 2011, making electric power the second largest natural gas consuming sector by 1998. Throughout the 1949-2011 period, however, the industrial sector consumed more natural gas than any other sector. Industrial consumption varied according to several factors, including overall industrial output, the price of substitute fuels, and gains in process efficiencies. In 2011, the industrial sector accounted for 33 percent of natural gas consumption, and the electric power sector accounted for 31 percent.

Fig. 2: US Natural Gas Consumption

Natural gas prices have declined significantly during the past several years, mainly due to the increase of supply from shale gas, as indicated in Fig. 3 and Fig. 4 [6], and so it is likely natural gas will remain a central player for some years to come.

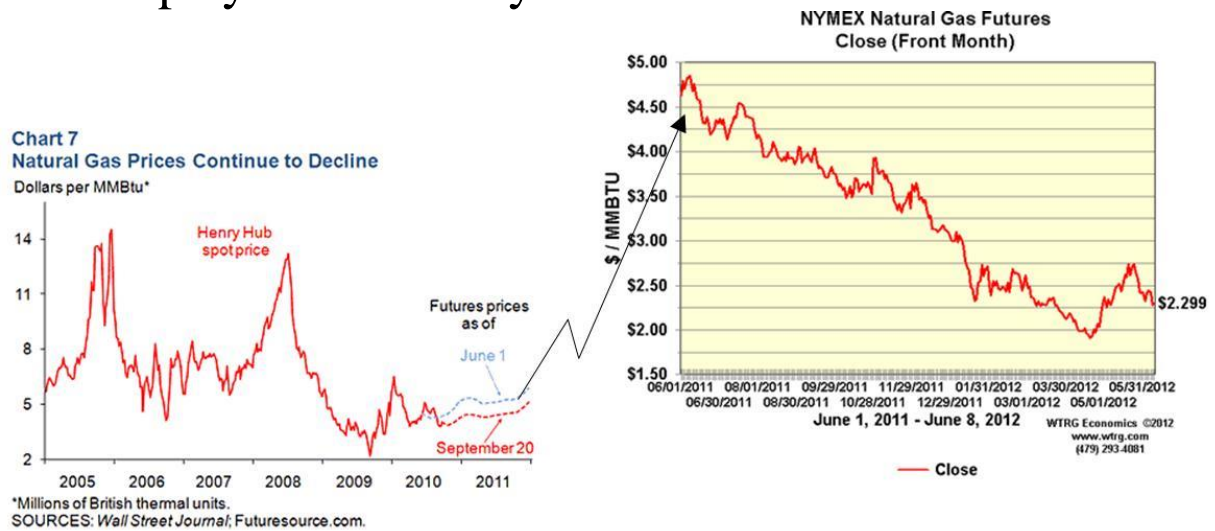
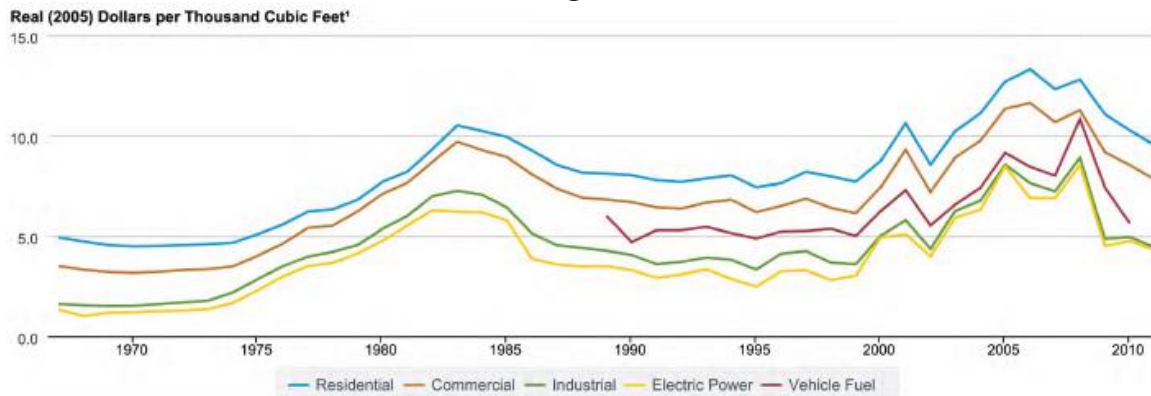

Fig. 3



U.S. Energy Information Administration, Annual Energy Review, Table 6.8.

¹ In chained (2005) dollars, calculated by using gross domestic product implicit price deflators. See "Chained Dollars" in Glossary.

Adjusted for inflation, natural gas prices in the different sectors of the economy generally rose and fell in unison. Because residential and commercial natural gas prices were based on higher per unit charges for lower usage, they were higher than industrial and electric power sector prices in every year from 1967 to 2011. From 2008 to 2011, real prices fell 25 percent in the residential sector, 31 percent in the commercial sector, and 50 percent in the industrial and electric power sectors.

Fig. 4

Planned capacity will continue to emphasize gas and wind plants, as indicated in Fig. 5 below [7]. This figure reflects predicted cumulative capacity in each

year. Careful inspection of the figure indicates most of the 100GW growth occurs in natural gas and renewable resources. The report indicates that most of the renewable resources is wind.

Figure 17: NERC-Wide Long-Term Projected On-Peak Capacity

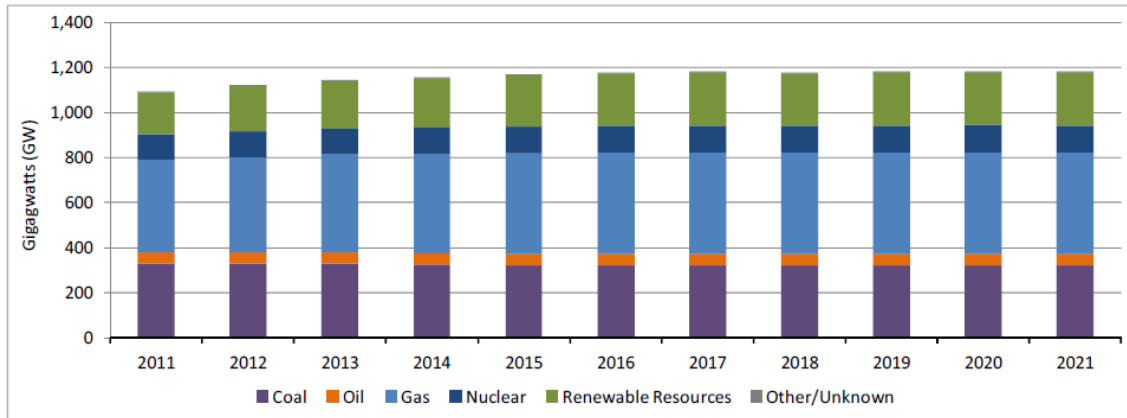

Fig. 5

3.0 Fuels continued – transportation & emissions

The ways of moving bulk quantities of energy in the nation are via rail & barge (for coal), gas pipeline, & electric transmission, illustrated in Fig. 6.

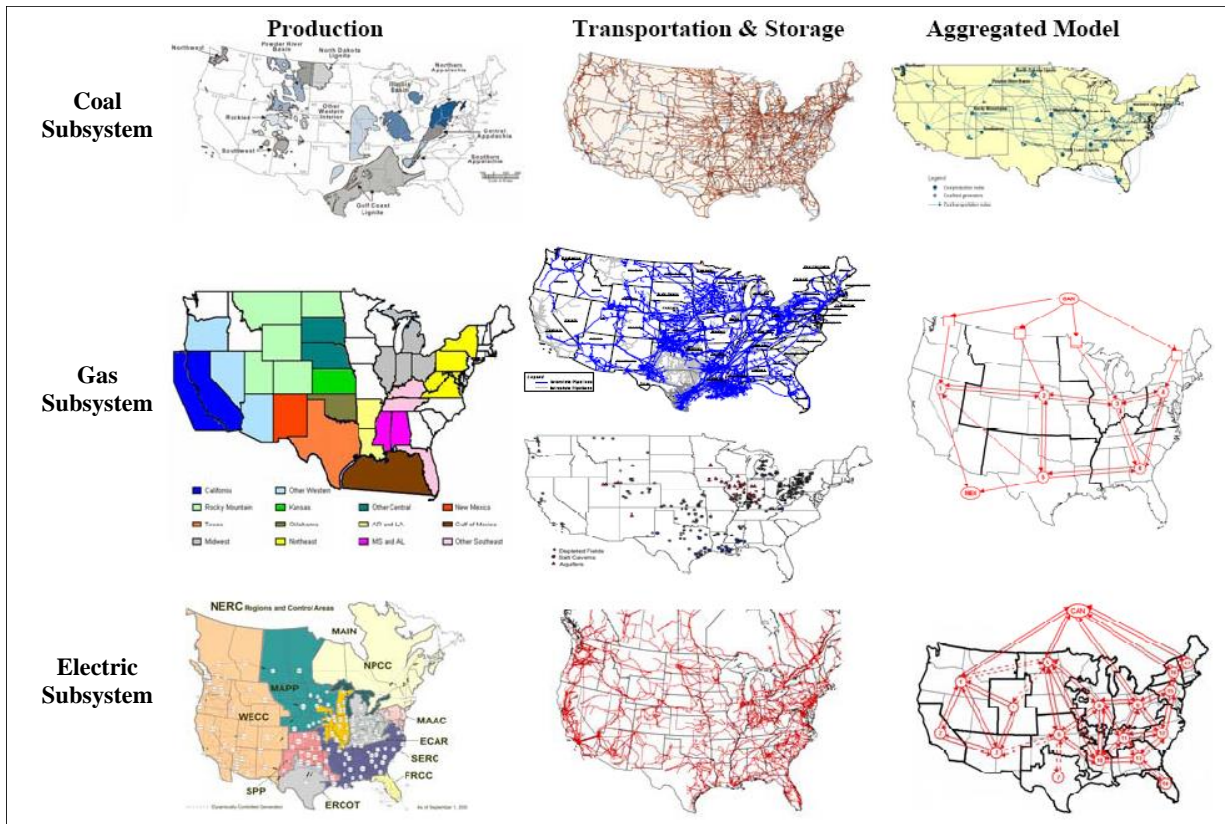

Fig. 6

An important influence in the way fuel is moved is the restriction on sulfur dioxide (SO₂):

- Cap-and-trade: control SO₂ emissions
- 1 allowance=1 ton SO₂, compliance period: 1 yr.

Compliance strategies:

- Retrofit units with scrubbers
- Build new power plants w/ low emission rates
- Switch fuel (or source of fuel)
- Trade allowances with other organizations
- Bank allowances
- Purchase power
- National annual emission limit: ~ 9 million tons

- Emissions produced depends on fuel used, pollution control devices installed, and amount of electricity generated
- Allowance trading occurs directly among power plants (with a significant amount representing within-company transfers), through brokers, and in annual auctions conducted by the US Environmental Protection Agency (EPA).

The US Environmental Protection Agency (EPA) modified the cap and trade system for SO₂ via its Cross-State Air Pollution Rule (CSAPR). CSAPR expanded the SO₂ cap-and-trade program to four cap-and-trade programs, one each for SO₂ group 1 (more stringent limits), SO₂ group 2, NO_x annual, and NO_x seasonal. However, this EPA ruling was challenged in the courts and no final decision has been rendered yet.

Coal is classified into four ranks: lignite (Texas, N. Dakota), sub-bituminous (Wyoming), bituminous (central Appalachian), anthracite (Penn), reflecting the progressive increase in age, carbon content, and heating value per unit of weight.

Table 3 below illustrates differences among coal throughout the country, in terms of capacity, heat value, sulfur content, and minemouth price. Appalachian coal is primarily bituminous, mainly

mined underground, whereas Wyoming coal is subbituminous, mainly mined from the surface.

Table 3

Supply node	Productive capacity (thousand short tons)	Avg. heat value (MMBtu/ton)	Avg. sulfur content (lbs. sulfur/MMBtu)	Avg. minemouth price (2002 \$/short ton)
Northern Appalachia	169,819	24.04	1.83	24.79
Central Appalachia	335,926	25.03	0.75	30.18
Southern Appalachia	28,221	24.66	0.57	33.61
Illinois Basin	121,801	22.73	2.03	22.86
Western Interior	2,538	23.58	2.28	27.86
Gulf Coast Lignite	56,063	13.10	1.62	17.02
North Dakota Lignite	32,400	13.24	1.15	8.46
Powder River Basin	479,761	17.45	0.39	6.63
Rocky Mountains	75,185	22.81	0.40	17.96
Southwest	56,653	20.22	0.63	22.47
Northwest	7,284	15.63	1.13	8.92

Although the above table is a little dated, its general message is still relevant, as confirmed by the figures below [8], where we see western coal production climbing, due to facts that (a) its \$/BTU is much more attractive, and (b) it has low sulfur content.

Figure 78. Coal production by region, 1970-2030 (quadrillion Btu)

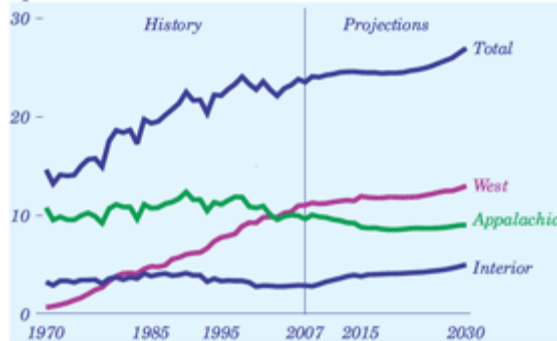
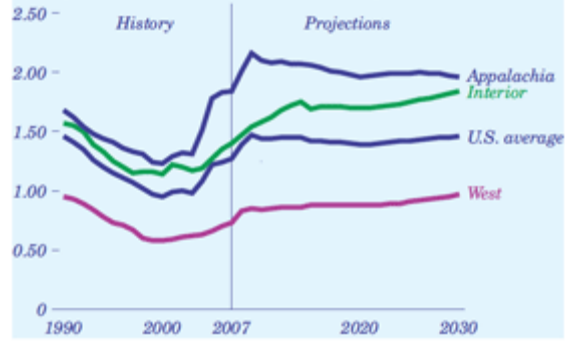

Figure 80. Average minemouth coal prices by region, 1990-2030 (2007 dollars per million Btu)



As a result, a great deal of coal is transported from Wyoming eastward, as illustrated in Fig. 7.

The Coal Dog.... Powder River Basin Coal Movement



23

Fig. 7

We do not have a national CO₂ cap and trade market yet, but there is a regional one called the Regional Greenhouse Gas Initiative (RGGI) – see <http://www.rggi.org/home>. In 2008, there was serious discussion ongoing to develop a national one, as the Waxman-Markey bill passed the house. However, its companion Kerry-Boxer bill in the senate did not pass. Kerry-Lieberman-Graham unveiled a 2nd version of the senate bill on 12/10/09, which also did not pass. This would have been very important to costs of energy production. For example, a “low” CO₂ cost would be about \$10/ton of CO₂ emitted, which would increase energy cost from a typical coal-fired plant from about \$60/MWhr to about \$70/MWhr. All indications are that today, it is dead.

4.0 CO₂ Emissions - overview

There is increased acceptance worldwide that global warming is caused by emission of greenhouse gasses into the atmosphere. These greenhouse gases are (in order of their contribution to the greenhouse effect on Earth) [9]:

- Water vapor: causes 36-70% of the effect
- Carbon dioxide (CO₂): causes 9-26% of the effect
- Methane (CH₄): causes 4-9% of the effect
- Nitrous oxide (N₂O):
- Ozone (O₃): causes 3-7% of the effect
- Chlorofluorocarbons (CFCs) are compounds containing chlorine, fluorine, and carbon, (no H₂). CFCs are commonly used as refrigerants (e.g., Freon).

The DOE EIA was publishing an excellent annual report on annual greenhouse gas emissions in the US, for example, the one published in November 2007 (for 2006) is [10], and the one published in December 2009 (for 2008) is [11]. All such reports, since 1995, may be found at [12]. One figure from the report for 2006 is provided below as Figure 8. The information that is of most interest to us in this table is in the center, which is summarized in Table 4.

Note that each greenhouse gas is quantified by “million metric tons of carbon dioxide equivalents,” or MMTCO₂e. Carbon dioxide equivalents are the amount of carbon dioxide by weight emitted into the atmosphere that would produce the same estimated radiative forcing as a given weight of another radiatively active gas [10].

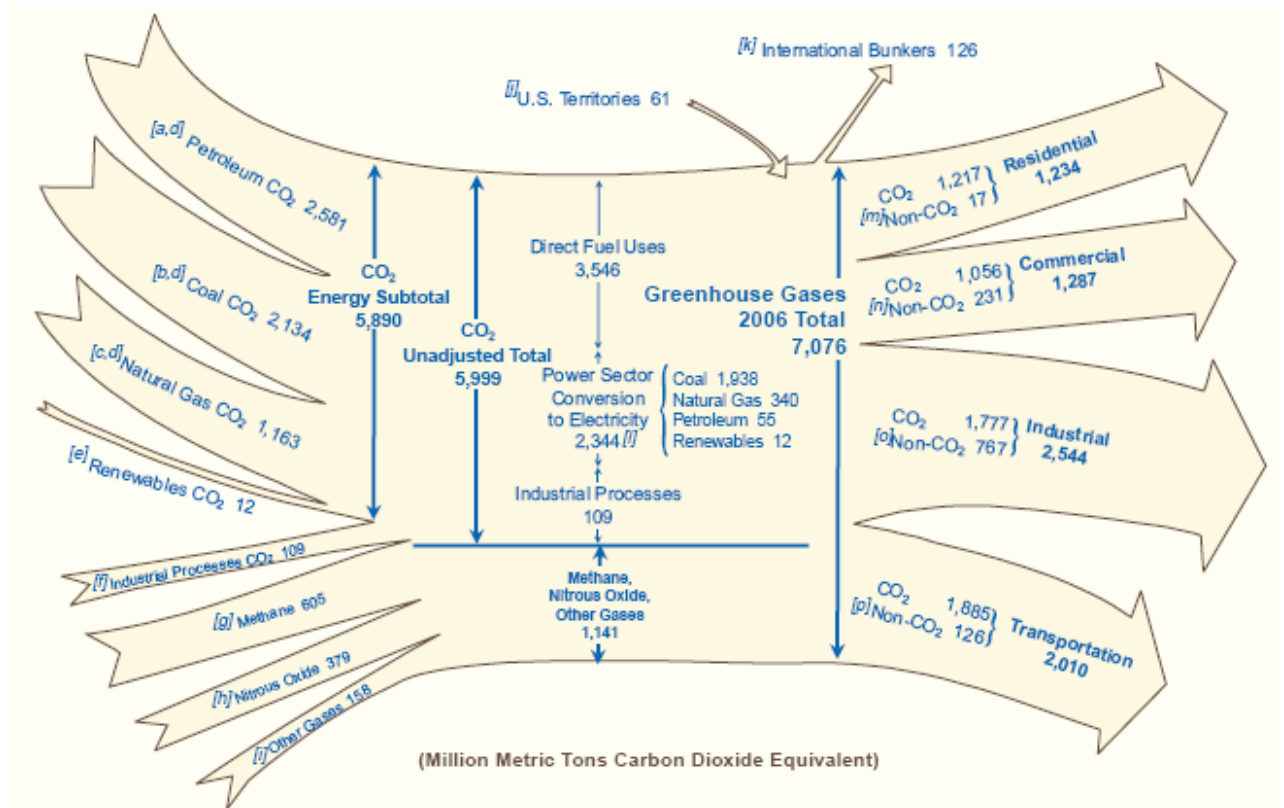

Fig. 8: Summary of US Greenhouse Gas Emissions, 2006

Table 4: Greenhouse Gas Total, 2006

Sectors	MMTCO ₂ e	% total CO ₂	% total GHG
From Power Sector	2344	39.1	32.8**
*From DFU-transp	1885	31.4	26.4**
*From DFU-other	1661	27.7	23.3**
From ind. processes	109	1.8	1.5**
Total CO ₂	5999	100	84.0
Non-CO ₂ GHG	1141		16.0
Total GHG	7140		100.

*The direct fuel use (DFU) sector includes transportation, industrial process heat, space heating, and cooking fueled by petroleum, natural gas, or coal. The DFU-transportation CO₂ emissions of 1885 MMT was obtained from the lower right-hand-side of Fig. 9a. The DFU-other CO₂ emissions of 1661 MMT was obtained as the difference between total DFU emissions of 3546 MMT (given at top-middle of Fig. 9a) and the DFU-transportation emissions of 1885 MMT.

** The “% total GHG” for the 4 sectors (power, DFU-transp, DFU-other, and ind processes) do not include the Non-CO₂ GHG emitted from these four sectors, which are lumped into the single row “Non-CO₂ GHG.” If we assume that each sector emits the same percentage of Non-CO₂ GHG as CO₂, then the numbers under “% total CO₂” are representative of each sector’s aggregate contribution to CO₂ emissions. The only sector we can check this for is transportation, where we know Non-CO₂ emissions are 126MMT, which is only 11% of the 1141 MMT total non-CO₂, significantly less than the % of total CO₂ for transportation, which is 31.4%.

Figure 9 [11] is the same picture as Fig. 8 except it is for the year 2008; the information is summarized in Table 5.

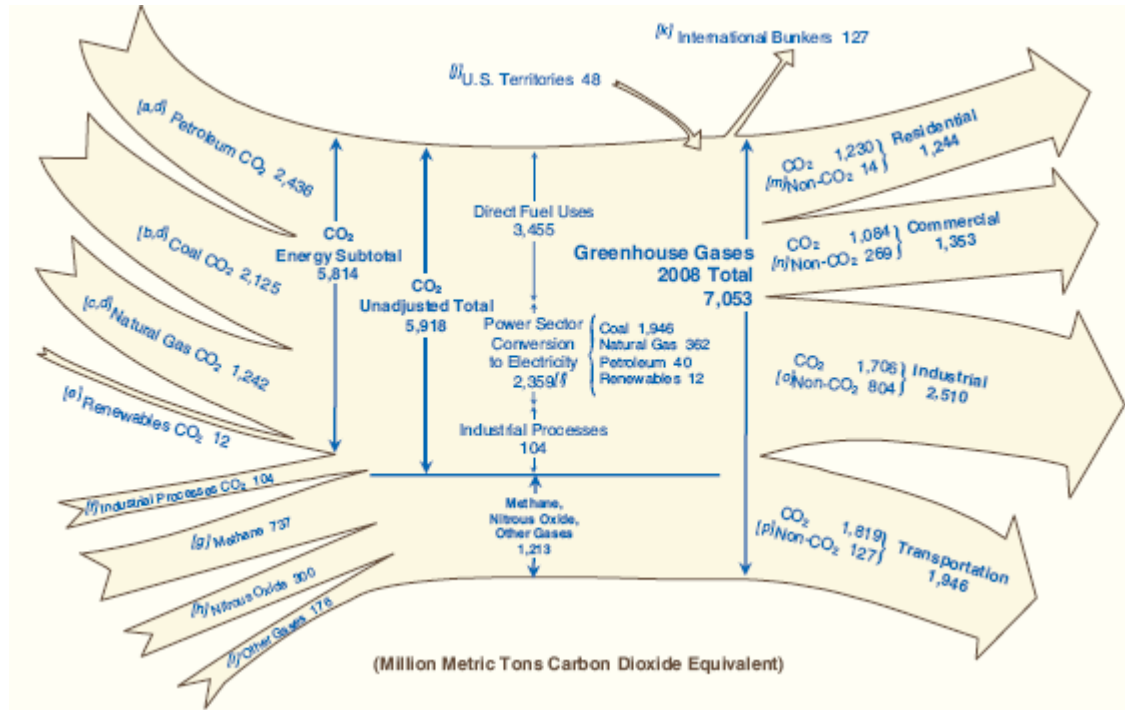

Fig. 9: Summary of US Greenhouse Gas Emissions, 2008

Table 5: Greenhouse Gas Total, 2008

Sectors	MMT CO ₂ e	% total CO ₂	% total GHG
From Power Sector	2359	39.8	33.18**
*From DFU-transp	1819	30.8	25.5**
*From DFU-other	1636	27.6	22.9**
From ind. processes	104	1.8	1.5**
Total CO ₂	5918	100	83.0
Non-CO ₂ GHG	1213		17.0
Total GHG	7131		100.

*The direct fuel use (DFU) sector includes transportation, industrial process heat, space heating, and cooking fueled by petroleum, natural gas, or coal. The DFU-transportation CO₂ emissions of 1819 MMT was obtained from the lower right-hand-side of Fig. 9b. The DFU-other CO₂ emissions of 1636 MMT was obtained as the difference between total DFU emissions of 3555 MMT (given at top-middle of Fig. 9b) and the DFU-transportation emissions of 1819 MMT.
 ** The “% total GHG” for the 4 sectors (power, DFU-transp, DFU-other, and ind processes) do not include the Non-CO₂ GHG emitted from these four sectors, which are lumped into the single row “Non-CO₂ GHG.” If we assume that each sector emits the same percentage of Non-CO₂ GHG as CO₂, then the numbers under “% total CO₂” are representative of each sector’s aggregate contribution to CO₂ emissions. The only sector we can check this for is transportation, where we know Non-CO₂ emissions are 127MMT, which is only 10.5% of the 1213 MMT total non-CO₂, significantly less than the % of total CO₂ for transportation, which is 30.8%.

Some numbers to remember from Tables 4 and 5 are

- Total US GHG emissions are about 7100 MMT/year.
- Of these, about 83-84% are CO₂.
- Percentage of GHG emissions from power sector is about 40% (see ** note for Tables 4 and 5).
- Percentage of GHG emissions from transportation sector is about 31% (see ** note for Tables 4 and 5).
- Total Power Sector + Transportation Sector emissions is about 71% (see ** note for Tables 4 and 5).

5.0 CO₂ Emissions – power sector

Figure 10 [11] shows that CO₂ emissions from the electric power sector have been generally rising from 1990 to 2008, but the fact that they are rising more slowly than power sector sales suggests that emissions per unit of energy consumed is decreasing. Note that the emissions values given in Fig. 10 have been normalized by the value in the year 2000, which was 2293.5 MMT.

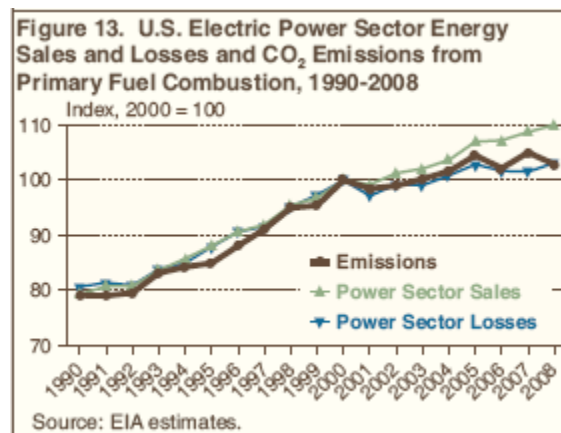
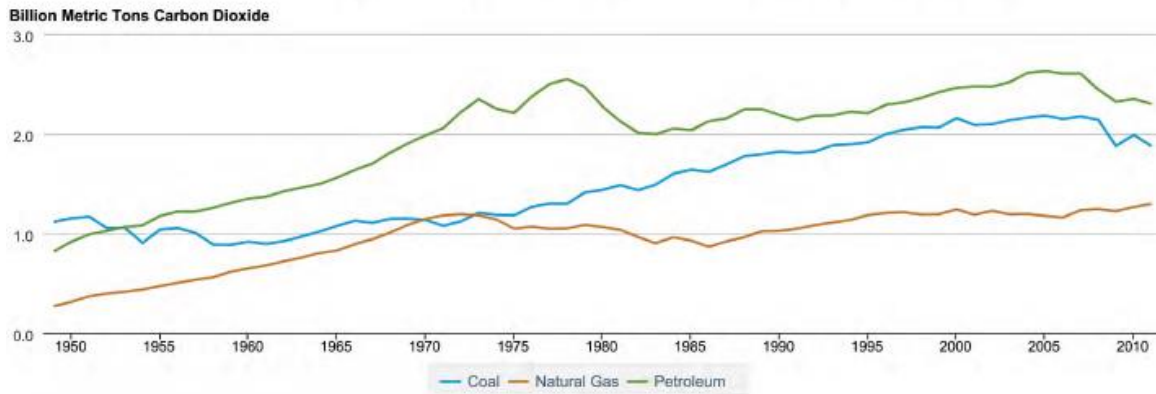

Fig. 10: Electric power sector CO₂ emissions by year

Figure 11 [6] provides another view of CO₂ emissions by fuel where it is clear that, recently, emissions from coal and petroleum dropped whereas that from natural gas increased.

40. Estimated U.S. Carbon Dioxide¹ Emissions From Energy Consumption by Major Source, 1949-2011



U.S. Energy Information Administration, *Annual Energy Review*, Table 11.1.

¹ Metric tons of carbon dioxide can be converted to metric tons of carbon equivalent by multiplying by 12/44.

Petroleum was the largest source of carbon dioxide (CO₂) emissions from energy use from the early 1950s through 2011. CO₂ emissions from petroleum consumption reached a record high in 2005, dropped off substantially in 2008 and 2009, and decreased again in 2011. Coal was the second largest energy source of CO₂ emissions from the early 1970s through 2011.

Fig. 11

Table 6 [11] shows the year-by-year breakdown of electric power sector CO₂ emissions by fuel. We see the dominant contributor is coal, with natural gas a distant second.

Table 6: Yearly breakdown of electric sector CO₂ emissions

Fuel	1990	1995	2000	2002	2003	2004	2005	2006	2007	2008
Petroleum										
Residual Fuel Oil	91.6	44.6	68.6	51.9	68.5	69.3	69.1	28.4	31.3	18.8
Distillate Fuel Oil	7.1	7.9	12.8	9.3	11.8	8.1	8.4	5.4	6.5	5.2
Petroleum Coke	3.1	8.2	10.1	17.9	17.8	22.7	24.9	21.8	17.5	15.8
Petroleum Subtotal . . .	101.8	60.7	91.5	79.1	98.1	100.1	102.3	55.6	55.3	39.7
Coal	1,531.2	1,648.7	1,910.8	1,872.4	1,910.7	1,922.9	1,963.9	1,937.8	1,970.6	1,945.9
Natural Gas	175.5	228.2	280.9	306.0	278.3	296.8	319.1	338.2	371.7	362.0
Municipal Solid Waste . .	5.7	9.9	10.0	12.6	11.3	11.1	11.1	11.4	11.2	11.2
Geothermal	0.4	0.3	0.4	0.4	0.4	0.4	0.4	0.4	0.4	0.4
Total	1,814.6	1,947.9	2,293.5	2,270.5	2,298.8	2,331.3	2,396.8	2,343.5	2,409.1	2,359.1

Notes: Data in this table are revised from the data contained in the previous EIA report, *Emissions of Greenhouse Gases in the United States 2007*, DOE/EIA-0573(2007) (Washington, DC, December 2008). Emissions for total fuel consumption are allocated to end-use sectors in proportion to electricity sales. Totals may not equal sum of components due to independent rounding.
Source: EIA estimates.

Table 6 is for CO₂ emissions only – it does not include Non-CO₂ emissions.

Coal is the largest contributor to CO₂ emissions. For example, in year 2008, it contributed 1945.9 MMT, 82.5% of the total power sector CO₂ emissions. The next highest contributor was natural gas, at 362 MMT, which is 15.3% of the total. The two combined account for 97.8% of power sector CO₂ emissions.

A more recent indicator is [13] which provides CO₂ emissions for the electricity sector by source, as shown in the below table.

Source	2008		2014	
	Million metric tons	Share of total	Million metric tons	Share of total
Coal	1946	82.5%	1,562	76%
Natural gas	362	15.3%	444	22%
Petroleum	40	1.7%	23	1%
Other ³	12	<1%	11	<1%
	2359		2043	

In 2014, the total CO₂ emissions from gas are only 28% of Total CO₂ emissions from coal. **This does NOT imply that**

- CO₂ emissions per MWhr from a natural gas power plant are 28% of the
- CO₂ emissions per MWhr from a coal-fired power plant!!!

The fact that coal is the largest contributor to GHG emissions is due to

- it is used to produce just under half of US electricity,
- it has the highest emissions/energy content ratio, as indicated by Table 7 below [14],
- its average conversion efficiency is not very good.

Table 7: Emission Coefficients for Different Fuels

Fuel	Code	Emission Coefficients		
		Pounds CO ₂ per Unit Volume or Mass		Pounds CO ₂ per Million Btu
Petroleum Products				
Aviation Gasoline	AV	18.355	per gallon	152.717
Distillate Fuel (No. 1, No. 2, No. 4 Fuel Oil and Diesel)	DF	22.384	per gallon	161.386
Jet Fuel	JF	21.095	per gallon	156.258
Kerosene	KS	21.537	per gallon	159.535
Liquified Petroleum Gases (LPG)	LG	12.805	per gallon	139.039
Motor Gasoline	MG	19.564	per gallon	156.425
Petroleum Coke	PC	32.397	per gallon	225.13
Residual Fuel (No. 5 and No. 6 Fuel Oil)	RF	26.033	per gallon	173.906
Natural Gas and Other Gaseous Fuels				
Methane	ME	116.376	per 1000 ft ³	115.258
Landfill Gas	LF	1	per 1000 ft ³	115.258
Flare Gas	FG	133.759	per 1000 ft ³	120.721
Natural Gas (Pipeline)	NG	120.593	per 1000 ft ³	117.08
Propane	PR	12.669	per gallon	139.178
Coal				
Anthracite	AC	5685	per short ton	227.4
Bituminous	BC	4931.3	per short ton	205.3
Subbituminous	SB	3715.9	per short ton	212.7
Lignite	LC	2791.6	per short ton	215.4
Renewable Sources				
Biomass	BM	Varies depending on the composition of the biomass		
Geothermal Energy	GE	0		0
Wind	WN	0		0
Photovoltaic and Solar Thermal	PV	0		0
Hydropower	HY	0		0
Tires/Tire-Derived Fuel	TF	6160	per short ton	189.538
Wood and Wood Waste 2	WW	3812	per short ton	195
Municipal Solid Waste 2	MS	1999	per short ton	199.854
Nuclear				
	NU	0		0

One indication from Table 7, that the pounds CO₂/MBTU is based on energy content of the fuel, could be misleading. What is of more interest is the CO₂/MWhr obtained from the fuel together with a particular generation technology. To get this, we need efficiencies of the generation technologies. Fig. 12 provides such efficiencies; the resource from which it came [15] provides a good overview of various factors affecting generation efficiencies.

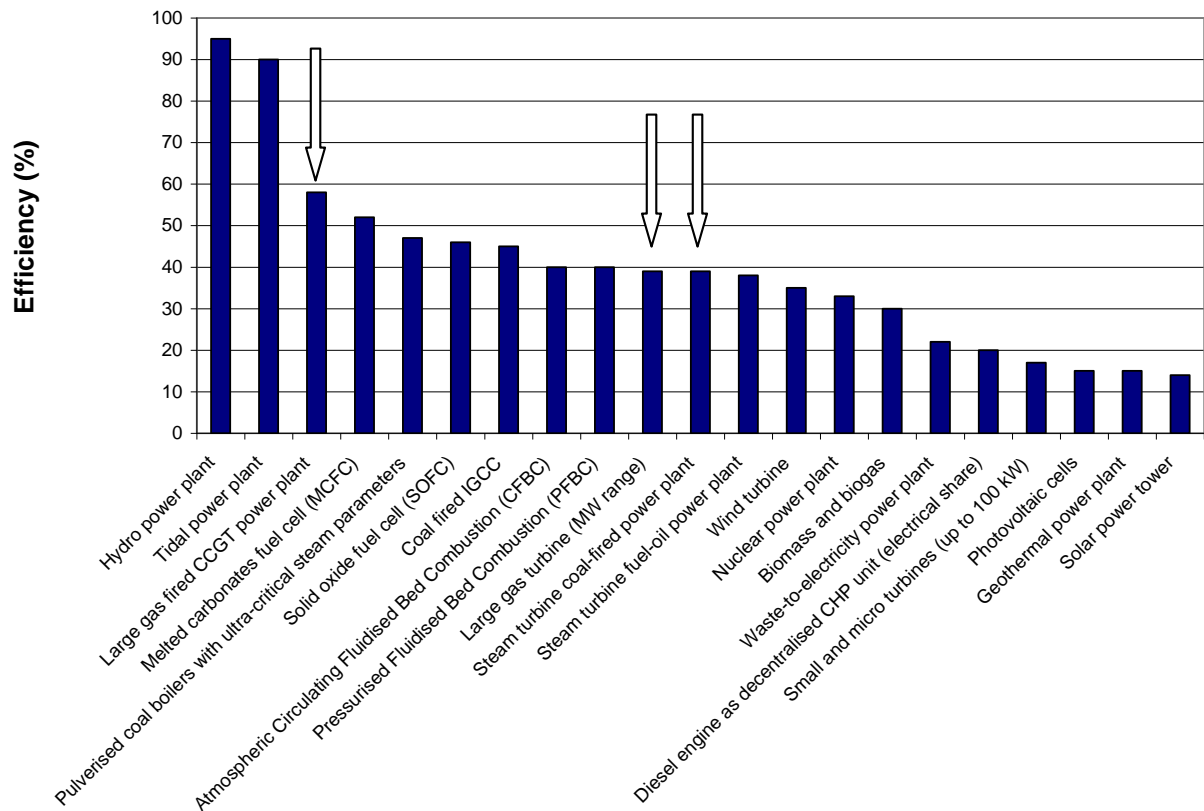

Fig. 12: Generation efficiencies

Table 7 and Fig. 12 provide the ability to compare different technologies in terms of CO₂/MWhr. For example, let's compare a natural gas combined cycle (NGCC) plant ($\eta=.58$), a gas turbine ($\eta=.39$), and a coal-fired power plant ($\eta=.39$), where the CO₂ content of the natural gas is 117.08 lbs/MBTU and the CO₂ content of the coal, assuming it uses (Powder River Basin) sub-bituminous coal is 212.7 lbs/MBTU. (Note that coal has a different energy & CO₂ content, depending on type, as shown below [16]).

Table 8.6. Carbon Dioxide Emission Factors in EPA Base Case 2000

Fuel	Carbon Dioxide (lbs/mmBtu)
Bituminous Coal	205.3
Subbituminous Coal	212.7
Lignite	215.4

$$\text{NGCC: } 117.08 \frac{\text{lbs}}{\text{MBTU}_{IN}} \times \frac{1\text{MBTU}_{IN}}{.58\text{MBTU}_{OUT}} \times \frac{3.41\text{MBTU}}{\text{MWhr}} = 688.5\text{lbs} / \text{MWhr}$$

Gas turbine:

$$117.08 \frac{\text{lbs}}{\text{MBTU}_{IN}} \times \frac{1\text{MBTU}_{IN}}{.39\text{MBTU}_{OUT}} \times \frac{3.41\text{MBTU}}{\text{MWhr}} = 1023.7\text{lbs} / \text{MWhr}$$

Coal-fired plant:

$$212.7 \frac{\text{lbs}}{\text{MBTU}_{IN}} \times \frac{1\text{MBTU}_{IN}}{.39\text{MBTU}_{OUT}} \times \frac{3.41\text{MBTU}}{\text{MWhr}} = 1859.8\text{lbs} / \text{MWhr}$$

Table 8 below, from [17], indicates similar numbers for a pulverized coal (PC) plant, a circulating fluidized bed (CFB) plant, an integrated gasification combined cycle (IGCC) plant, and a combined cycle plant. Note that the fuels for the first three of these are all coal, and they have similar emissions/MWhr ratios. The combined cycle plant has a bit higher ratio (810 instead of 688.5) because it used a lower efficiency (49.3% instead of 58%).

Table 8

Constituent	Unit	PC	CFB	IGCC	Combined Cycle
Fuel		Coal	Coal	Coal	Natural Gas
NO _x	lb/MBtu	0.05 - 0.07	0.07 - 0.11	0.055 - 0.10	0.007-0.013
	lb/MWh	0.55	0.85	0.68	0.07
SO ₂	lb/MBtu	0.06 - 0.1	0.04 - 0.13	0.015 - 0.045	0.0006
	lb/MWh	0.74	0.80	0.27	0.004
PM/PM ₁₀ (filterable)	lb/MBtu	0.012 - 0.015	0.012 - 0.015	0.005 - 0.01	~ 0.020 - 0.025
	lb/MWh	0.12	0.13	0.07	0.15
CO ₂	lb/MBtu	205-220	205-220	205-220	117
	lb/MWh	1950	1990	1910	810

Notes:
 Mercury regulation has recently been vacated. New permitting efforts will proceed on a case-by-case basis.
 Air emissions based on 100 percent load.
 CO2 emissions are not currently regulated.
 IGCC is without CO₂ capture and storage.

In the calculations at the top of the previous page, one can recognize that the $3.41/\eta$ factor in each equation is just the unit heat rate in MBTU/MWhr. This means the same calculation can be done by multiplying the $\text{lbs/MBTU}_{\text{IN}}$ factor from Table 7 by the average heat rate for the plant.

We can also convert the above to Metric tons/MWhr by dividing by 2204 lbs/Metric ton, to get the following figures:

- NGCC: 0.464 MT/MWhr
- Gas turbine: 0.312 MT/MWhr
- Coal-fired plant: 0.844 MT/MWhr.

It is interesting to compare these values with the emission coefficients given by region/state at [18]. A sample of some of these coefficients are provided below (this is 2002 data):

New York:	0.389
Vermont:	0.013
Penn:	0.574
Ohio:	0.817
Iowa:	0.854
N. Dakota:	1.017
Georgia:	0.619
Kentucky:	0.911
Texas:	0.664
California:	0.275
Washington:	0.111
US Average:	0.606

Why is Iowa so high? Why are N.Dakota & Kentucky so high? Why is California so low? Why is Washington so low? Why is Vermont so low?
--

Vermont is so low because it has only one small fossil-fired unit (a diesel unit), and it is a peaker and so does not often run [19]. Almost 75% of Vermont's electric energy comes from a large nuclear facility (Vermont Yankee) and most of the rest comes from outside the state via the ISO-NE market. Iowa was, in 2002, heavily dependent on coal. Today, with Iowa's wind growth, it is less so, but still, coal is by far the dominant part of Iowa's generation portfolio.

6.0 Heat rates

The values of Table 1 (fuel cost table) reflect only the cost of fuel input to a generation plant; they do not reflect the actual costs of producing electrical energy as output from the plant because substantial losses occur during production. Some power plants have overall efficiencies as low as 30%; in addition, the plant efficiency varies as a function of the generation level P_g . We illustrate this point in what follows.

We represent plant efficiency by η . Then η =energy output/energy input. We obtain η as a function of P_g by measuring the energy output of the plant in MWhrs and the energy input to the plant in MBTU.

We could get the energy output by using a wattmeter to obtain P_g over a given period of time, say an hour, and we could get the energy input by measuring the coal tonnage used during the hour and then multiplying by the coal energy content in MBTU/ton.

We could then plot the fuel input in MBTU/hr as a function of the power output P_g in MW. Such a plot is called an *input-output curve*, indicating how much fuel rate is required to produce a power level. A typical input-output curve is shown in Fig. 13. We denote fuel rate (input, vertical axis of Fig. 1a) as R .

One notes that the I/O curve of Fig. 13 does not go to $P_g=0$. A generating unit has a minimum stable output, typically 10-30% for oil and natural gas-fired steam units and 20-50% for coal-fired steam units [20].

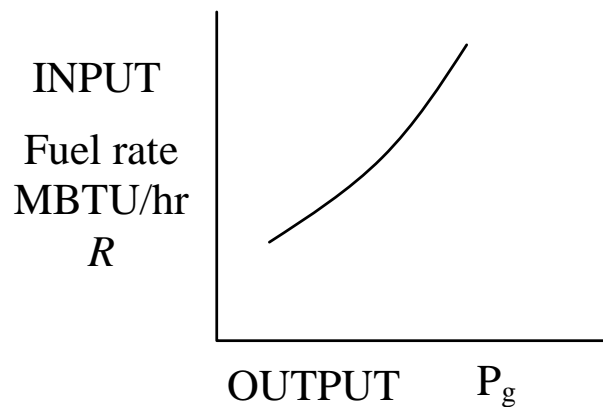

Fig. 13: Input-output curve

One interesting feature with respect to Fig. 13 is that as fuel input is increased, the power output per unit fuel input begins to decrease. We can see this more clearly if we invert the axes, as in Fig. 14, yielding a *production function*, where, for high enough fuel rates, we will get no additional power output.

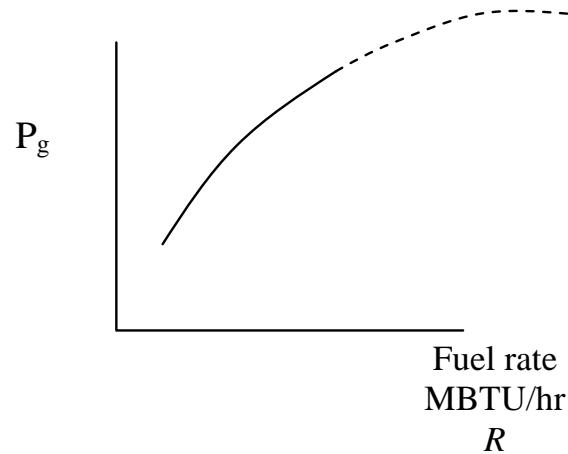

Fig. 14: Production function

Physically, this happens because the furnace, boiler, steam pipes leak a larger percentage of input heat as temperatures increase. Economists call this the [21] *law of diminishing marginal product*: for almost all processes, the rate of increase in output decreases as the input increases, assuming other inputs are fixed.

To obtain η , we want the output energy divided by the input energy, which is

$$\eta \sim P_g \div R$$

which in terms of units is MW \div MBTU/hr to give units of MWhr/MBTU. Notice that these units are energy/energy, as they should be when computing η . However, the MBTU and MWhr are different units of energy, and so we are not getting η exactly, but we are getting something proportional to η .

So let's obtain the ratio of the power to the fuel rate

$(P_g \div R)$ for every point on the input-output curve, and plot the results against P_g . Fig. 15 shows a plot of the ratio P_g/R (units of MWHR/MBTU) versus P_g .

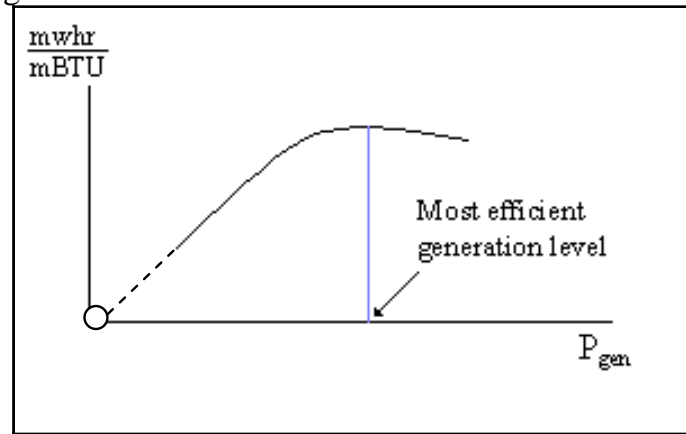

Fig. 15: Plot of MWhr/MBTU vs. P_g

Figure 15 indicates that efficiency is poor for low generation levels (a connected plant that is operating at zero MW output still has to supply station loads) and increases with generation, but at some optimum level it begins to diminish. Most power plants are designed so that the optimum level is close to the rated output.

The *heat rate* curve is similar to Fig. 15 except that the y-axis is inverted to yield MBTU/MWhrs, which is proportional to $1/\eta$. This curve is illustrated in Fig. 16. We denote heat rate by H . Since the heat rate depends on operating point, we write $H=H(P_g)$.

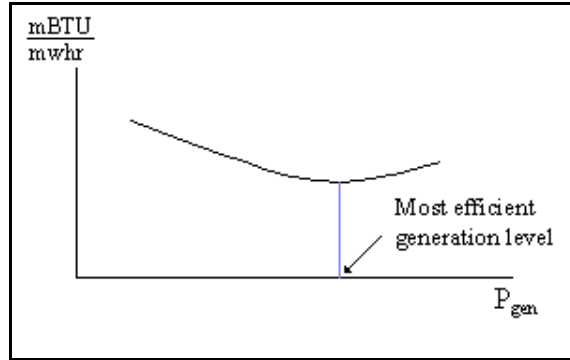

Fig. 16: Plot of Heat Rate (H) vs. Generation (P_g)

Some typical heat rates for units at maximum output are (in MBTU/MWhrs) 9.5-10.5 for fossil-steam units and nuclear units, 13.0-15.0 for combustion turbines [22], and 7.0-9.5 for combined cycle units. Future combined cycle units may reach heat rates of 6.5-7.0. *It is important to understand that the lower the heat rate, the more efficient the unit.*

An easy way to remember the meaning of heat rate $H=H(P_g)$ is it is the amount of input energy (MBTU) required to produce a MWhr, at generation level P_g.

How does H relate to efficiency? To answer this question, we need to know that there are 1054.85 joules per BTU.

$$\frac{1}{\eta} \sim H \frac{MBTU}{MWhr} = H \frac{1E6 BTU}{1E6 Whr} = H \frac{BTU(1054.85 j / BTU)}{(j/sec)3600sec}$$

$$\Rightarrow \frac{1}{\eta} = H \frac{1054.85}{3600} = \frac{H}{3.41} \Rightarrow H = \frac{3.41}{\eta}$$

Observe: We have seen this before when we computed CO₂ emissions per MWhr out (see pg. 20), e.g., for the NGCC plant:

$$117.08 \frac{lbs}{MBTU_{IN}} \times \frac{1MBTU_{IN}}{.58MBTU_{OUT}} \times \frac{3.41MBTU}{MWhr} = 688.5lbs / MWhr$$

We can see now that the above calculation can be thought of as

$$117.08 \frac{lbs}{MBTU_{IN}} \times \frac{3.41MBTU_{IN}}{.58MBTU_{OUT}} = \frac{3.41MBTU_{IN}}{\eta MBTU_{OUT}} = 688.5lbs / MWhr$$

or

$$117.08 \frac{lbs}{MBTU_{IN}} \times H = 688.5lbs / MWhr$$

where H in this case is 3.41/.58=5.88 MBTU/MWhr.

The heat rate curve is a fixed characteristic of the plant, although it can change if the cooling water temperature changes significantly (and engineers may sometimes employ seasonal heat rate curves). The heat rate curve may also be influenced by the time between maintenance periods as steam leakages and other heat losses accumulate.

The above use of the term “heat rate” is sometimes also called the “**average heat rate.**” This is because we get it by dividing absolute values of fuel input rate by absolute values of electric output power. For example, if you buy an apple at \$50 and a second one at \$10, the average cost of apples after buying the first apple is \$50/apple but after buying the second apple is \$(50+10)/2=\$30/apple.

This is different than **incremental heat rate**, as will be illustrated in the following example.

Example [23]: Consider the input-output curve for Plant X in Fig. 17.

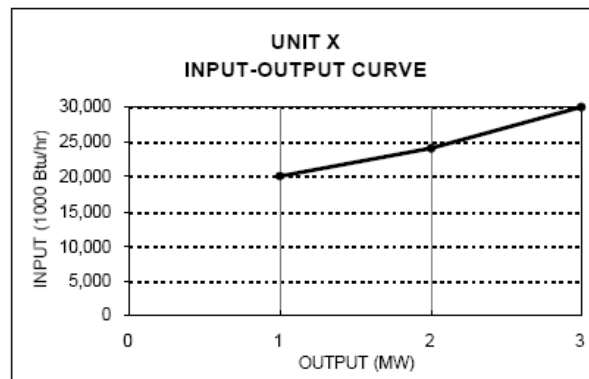

Fig. 17

Compute the average heat rate characteristic and the incremental heat rate characteristic.

Average heat rates are computed by dividing the fuel rate by the generation level, $H=R/P_g$, as follows:

$$\text{Block 1: } 20,000/1=20,000$$

$$\text{Block 2: } 24,000/2=12,000$$

$$\text{Block 3: } 30,000/3=10,000$$

Incremental heat rates computed by dividing the increment of fuel rate by the increment of power, $IH=\Delta R/\Delta P_g$ as follows:

$$\text{Block 1: } 20,000/1=20,000$$

$$\text{Block 2: } 4,000/1=4,000$$

$$\text{Block 3: } 6,000/1=6,000$$

These results are summarized in Table 9 below:

Table 9

	CAPACITY (MW)	INPUT-OUTPUT CURVE (1000 Btu/hr)	INCREMENTAL HEAT RATE (Btu/kWh)	AVERAGE HEAT RATE (Btu/kWh)
BLOCK 1	1	20,000	20,000	20,000
BLOCK 2	2	24,000	4,000	12,000
BLOCK 3	3	30,000	6,000	10,000

Figure 18 below illustrates the input-output curve, the average heat rate curve, and the incremental heat rate curve.

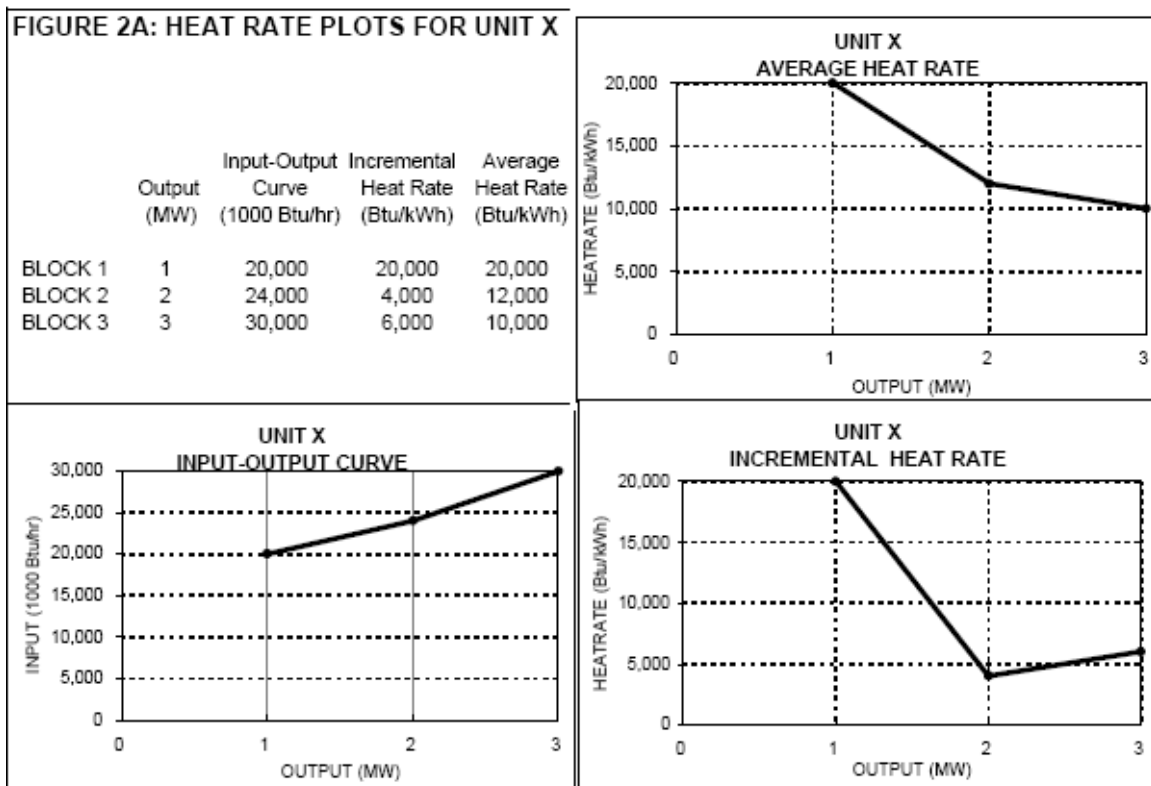

Fig. 18

We should note, however, that our first incremental heat rate value of 20,000 has a problem. This value assumes that the I/O curve extends as shown on the left hand side in Fig. 19 below. Probably a better

approximation would be to extend it as indicated on the right hand side of Fig. 19.

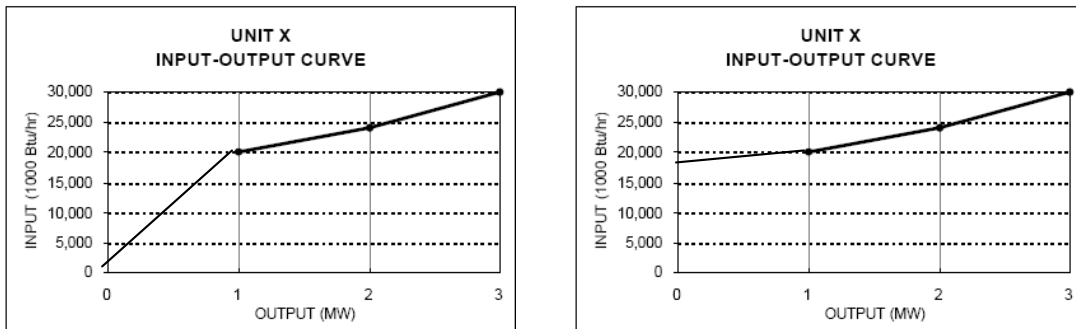

Fig. 19

Actually, it does not extend to 0 MW output because the unit, like all real units, has a minimum generation level.

Although you may see data entered which reflects a “high initial incremental value,” you should know that a value so computed does not represent a true incremental heat rate value at all.

Reference [23] also provides some actual data for units in California. The one below, Fig. 20, is one of the most efficient gas-fired units in the PG&E system. On the coast about 100 miles south of San Francisco, it is called Moss Landing Unit 7.

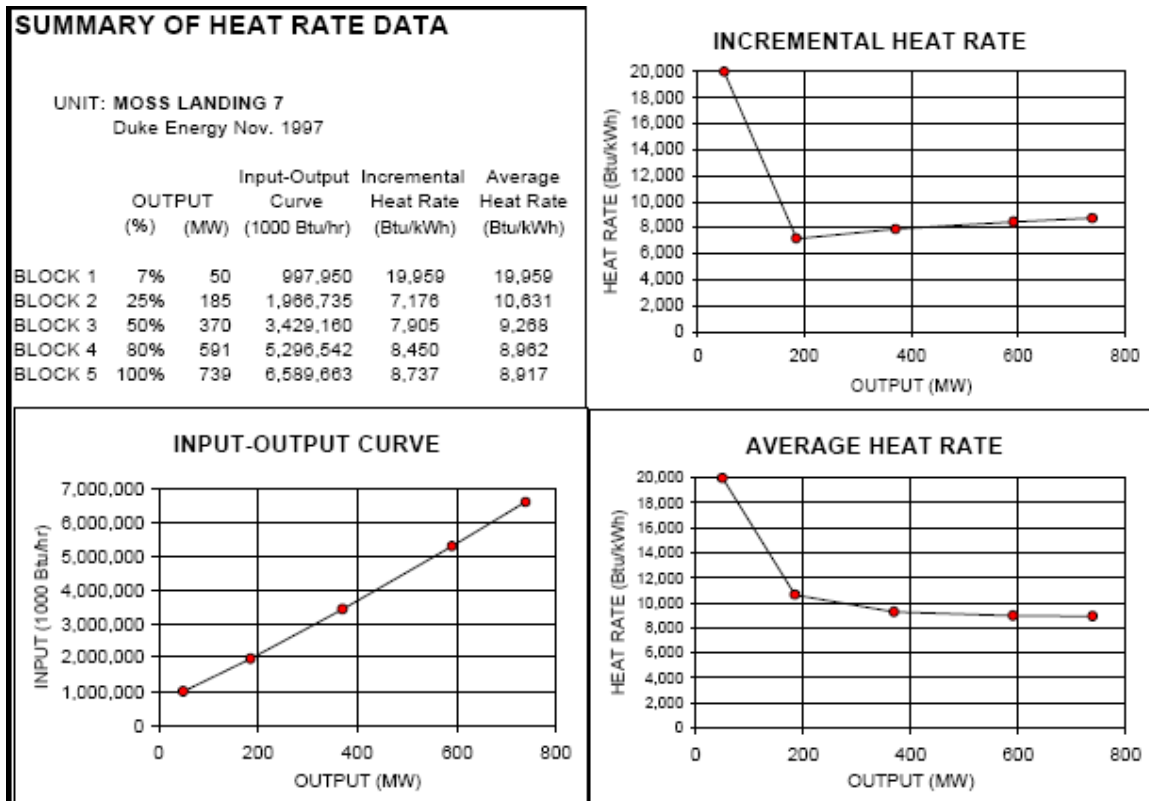

Fig. 20

Note that the Moss Landing unit 7 full-load average heat rate is 8.917 MBTU/MWhr, which gives an efficiency of $3.41/8.917=38.2\%$.

The next one, Fig. 21, is an old oil-fired unit in San Francisco called Hunter's Point.

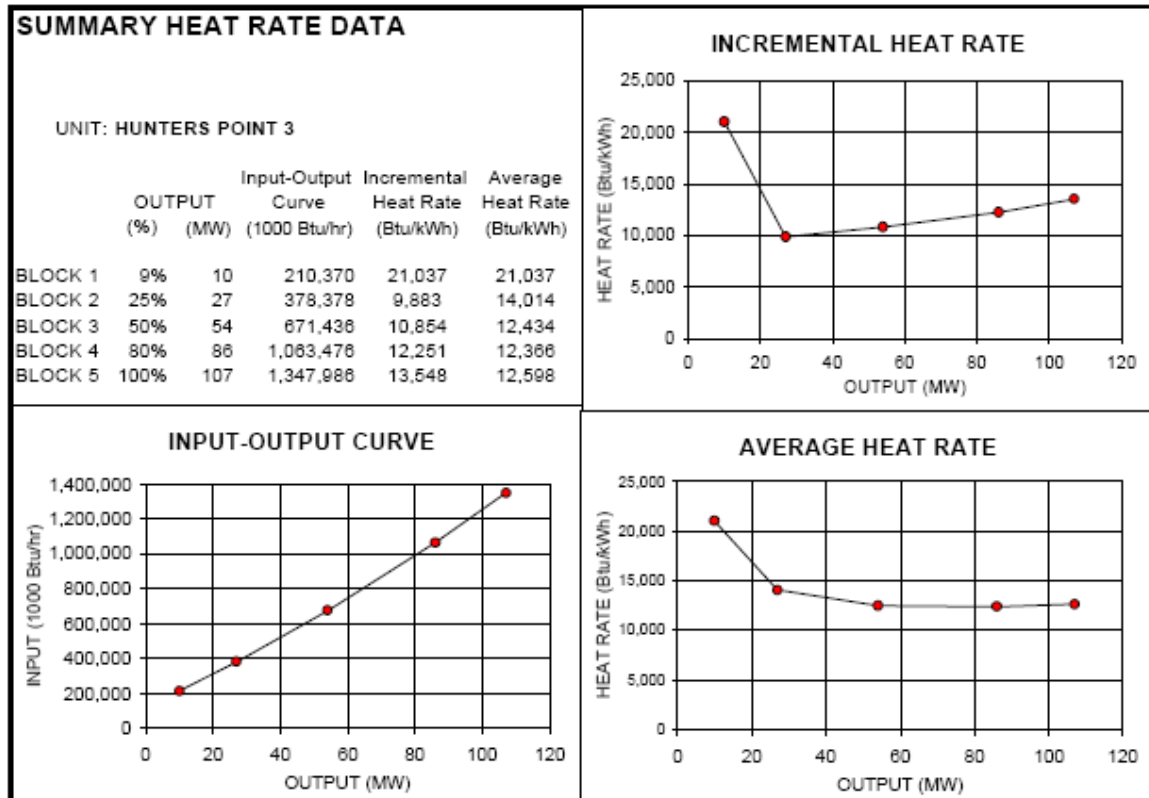

Fig. 21

Note the full-load average heat rate of this plant is 12.598 MBTU/MWhr, which corresponds to an efficiency of $3.41/12.598=27.1\%$.

This plant was built in 1927 and demolished in 2008.

7.0 Cost rates

We are primarily interested in how the cost per MWhr changes with P_g , because that will tell us something about how to achieve the most economic dispatch of generation for a given demand (we will see that optimality is achieved when marginal or incremental costs of all regulating units are equal).

To get cost per MWhr as a function of P_g , we will assume that we know K , the cost of the input fuel in \$/MBTU. Also, recall that

- R is the rate at which the plant uses fuel, in MBTU/hr (which is dependent on P_g) – it is just the input-output curve (see Fig. 13).

And we will denote

- C as the cost per hour in \$/hour.

Then, if $H(P_g)$, the heat rate, is the input energy used per MW per hour, then multiplying H by P_g gives input energy per hour, i.e., $R = P_g H(P_g)$ where H must be evaluated at P_g . Therefore, $C = RK = P_g H(P_g)K$, i.e., the cost rate function C is just the fuel rate function R scaled by the fuel cost.

A typical plot of C vs. P_g is illustrated in Fig. 22. Note that, because $H(P_g)$ is convex, $C(P_g)$ is also convex, i.e., the set of points lying on or above C contain all line segments between any pair of points.

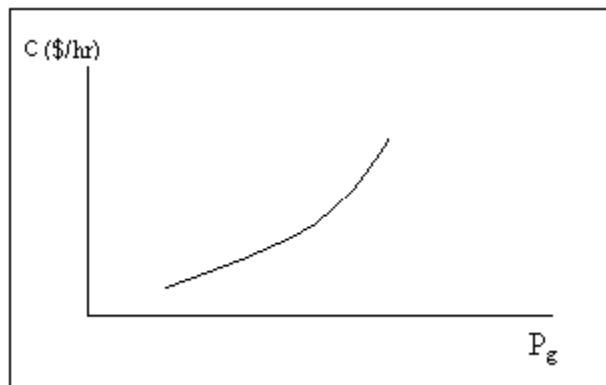

Fig. 22: Plot of cost per hr (C) vs. generation (P_g)

Fig. 22 shows that cost/hour increases with generation, a feature that one would expect since higher generation levels require greater fuel intake per hour.

The **incremental cost curve for the plant**, can be obtained by differentiating the plot in Fig. 22, i.e., by computing dC/dP_g . A typical incremental cost curve is shown in Fig. 23. Note that because C is convex, dC/dP_g is a non-decreasing function.

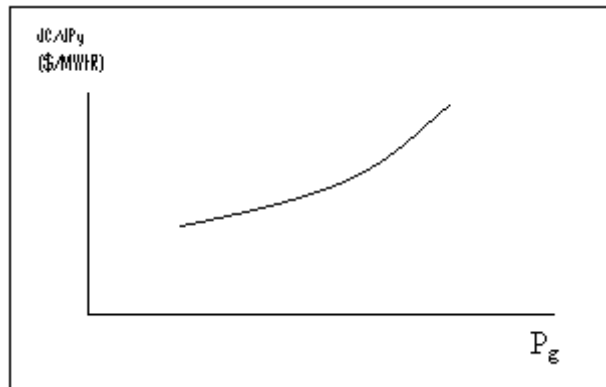

Fig. 23: Plot of incremental cost dC/dP_g vs. gen P_g

One last thing about getting incremental cost. Recall that the cost per hour is given by $C = RK$, where R is just the input-output curve. Therefore $IC = dC/dP_g = K(dR/dP_g)$. The derivative is the incremental heat rate, which we denoted by IH. Therefore, in summary:

$$C = RK = P_g H(P_g) K$$

$$IC = dC/dP_g = (dR/dP_g) K = (IH) K$$

Example 1

An 100 MW coal-fired plant uses a type of coal having an energy content of 12,000 BTU/lb. The coal cost is \$1.5/MMBTU. Typical coal usage corresponding to the daily loading schedule for the plant is as follows:

Table 10

Time of Day	Electric Output (MW)	Coal Used (tons)
12:00am-6:00am	40	105.0
6:00am-10:00am	70	94.5
10:00am-4:00pm	80	156.0
4:00pm-12:00am	100	270.0

For each of the four load levels, find (a) the efficiency η , (b) the heat rate H (MMBTU/MW hr) (c) the cost per hour, C (\$/hr). Also, for the loading levels of 40, 70, and 80 MW, use a piecewise linear plot of C vs P to obtain incremental cost IC as a function of unit loading P . Then plot incremental cost as a function of unit loading. The conversion factor from joules to BTU is 1054.85 joules/BTU, and the units for coal used, tons, are short-tons, 2000 lb/ton.

Solution

Let T be the number of hours the plant is producing P MW while using y tons of coal. We need to compute the total energy out of the plant and divide by the total energy into the plant, but we need both numerator and denominator to be in the same units. We will convert both to joules (recall a watt is a joule/sec).

$$(a) \quad \eta = \frac{P \text{ MW} \times T \text{ hr} \times \left(10^6 \frac{\text{watts}}{\text{MW}} \times 3600 \frac{\text{sec}}{\text{hr}} \right)}{y \text{ tons} \times \left(2000 \frac{\text{lb}}{\text{ton}} \times 12,000 \frac{\text{BTU}}{\text{lb}} \times 1054.85 \frac{\text{joules}}{\text{BTU}} \right)}$$

Note that the above expression for efficiency is dimensionless.

(b) The heat rate is the amount of MMBTUs used in the amount of time T divided by the number of MW-hrs output in the amount of time T .

$$H = \frac{y \text{ tons} \times \left(2000 \frac{\text{lb}}{\text{ton}} \times 12,000 \frac{\text{BTU}}{\text{lb}} \times \frac{1 \text{ MMBTU}}{10^6 \text{ BTU}} \right)}{P \times T}$$

Note that $H = \frac{1}{\eta} \times \frac{3600}{1054.85} = \frac{3.41}{\eta}$, and the above expression has units of MMBTU/MW_{hr}. Thus, if a unit is 100% efficient, then it will have a heat rate of 3.41 MMBTU/MW_{hr}, the absolute best (lowest) heat rate possible.

(c) $C = RK$ where R is the rate at which the plant uses fuel and K is fuel cost in \$/MMBTU. Note from units of P and H that

$$R = PH \rightarrow C = PHK \text{ where } H \text{ is a function of } P.$$

Application of these expressions for each load level yields the following results:

Table 11

T (hrs)	P (MW)	y (tons)	η	H (mbtu/m whr)	C (\$/hr)
6	40	105.0	0.33	10.5	630
4	70	94.5	0.42	8.1	850
6	80	156.0	0.44	7.8	936
8	100	270.0	0.42	8.1	1215

To obtain incremental cost $IC = \frac{dC}{dP}$, we can plot C vs. P and then get an approximation on the derivative by assuming a piecewise linear model as shown in Figure 24.

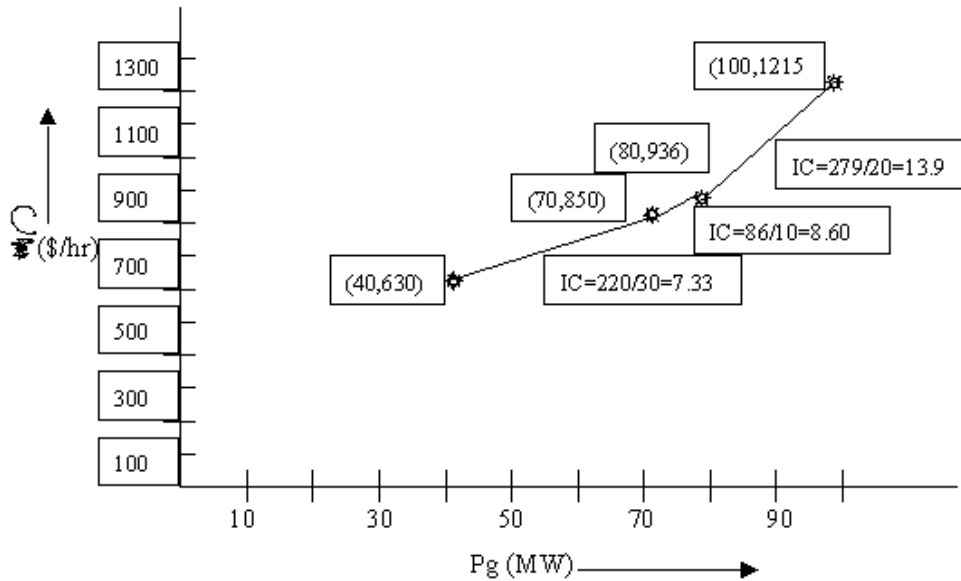

Figure 24: Calculation of Incremental Cost

The incremental costs are plotted as a function of loading in Fig. 25.

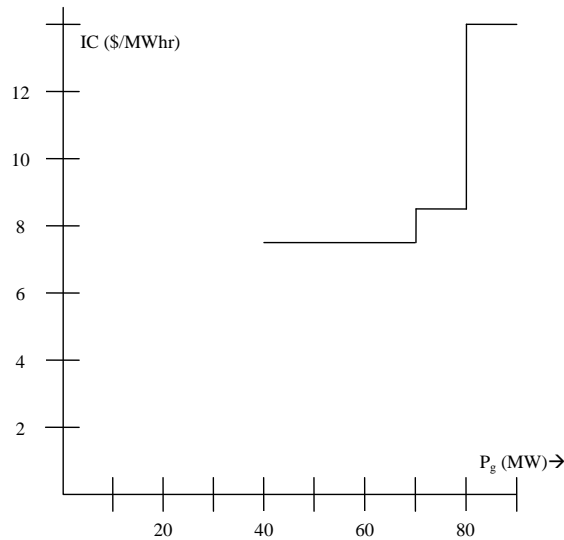

Fig 25: Incremental cost curve from piecewise-linear cost curve

We may use another procedure to model the incremental costs. In this procedure, we first fit the data to a quadratic polynomial. Matlab commands for doing so are below:

```
>> p=[40 70 80 100]';  
>> c=[630 850 936 1215]';  
>> X = [ones(size(p)) p p.^2];  
>> a=X\c  
a =  
604.8533  
-2.9553  
0.0903  
>> T = (0:1:100)';  
>> Y = [ones(size(T)) T T.^2]*a;  
>> plot(T,Y,'-',t,y,'o'), grid on
```

The quadratic function is therefore

$$C(P)=0.0903P^2-2.9553P+604.85$$

Figure 26 shows the plot obtained from Matlab.

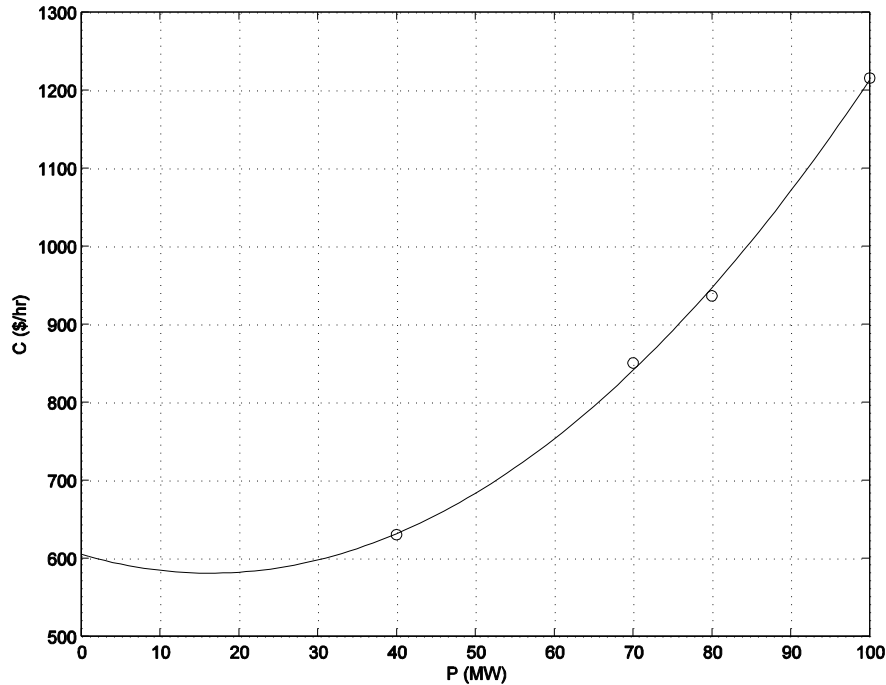

Fig 26: Quadratic Curve Fit for Cost Rate Curve

Clearly, the curve is inaccurate for very low values of power (note it is above \$605/hr at $P=0$ and decreases to about \$590/hr at $P=10$). We can get the incremental cost curve by differentiating $C(P)$:

$$IC(P)=0.1806P-2.9553$$

This curve is overlaid on the incremental cost curve of Fig. 25, resulting in Fig. 27. Both linear and discrete functions are approximate. Although the linear one appears more accurate in this case, it would be easy to improve accuracy of the discrete one by taking points at smaller intervals of P_g . Both functions should be recognized as legitimate ways to represent incremental costs. The linear function is often used in traditional economic dispatching; the discrete one is typical of market-based offers.

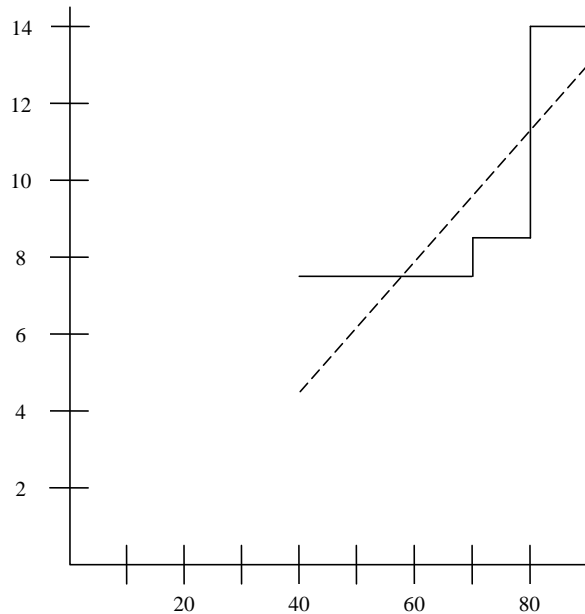

Fig. 27: Comparison of incremental cost curve obtained from piecewise linear cost curve (solid line) and from quadratic cost curve (dotted line)

8.0 Market-based offers

As indicated in the last section, electricity markets typically allow only piecewise linear representation of generator incremental cost curves.

The real-time and the day-ahead markets are implemented via computer programs based on optimization theory. The program used for the real-time market is called the security-constrained economic dispatch (SCED). This program, the SCED, is used together with a program called the security-constrained unit commitment (SCUC) program for the day-ahead market. Both the SCED and the SCUC

also solve for the ancillary service prices through a formulation known as co-optimization. We will say not say more about SCED and SCUC in these notes; instead, we will provide a simple description of how the energy market price is determined. This description is based on standard microeconomic theory but can be followed without background in microeconomics. However, one should note that the description necessarily omits some important concepts related to losses and congestion.

The following example is adapted from [24]. Consider that our electric energy market has three buyers, B1, B2, B3 and two sellers, S1, S2. The buyers represent load-serving entities, and the sellers represent generation owners. Consider that these buyers and sellers submit their bids (to buy) and their offers (to sell) via an internet system as shown in Fig. 28.

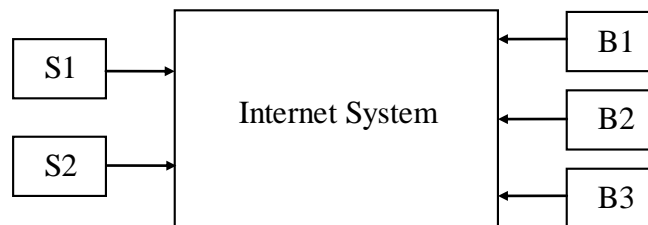

Figure 28: Illustration of buyer-seller interaction with internet-based market

Each seller has energy to sell, but the price they are willing to sell it for increases with the amount they sell. This is a reflection of the fact that the cost of producing 1 more unit of energy (MWhr) increases as a unit is loaded higher.

Likewise, each buyer wants to purchase energy, but the price they are willing to pay to obtain it decreases with the amount that they buy. This is just a reflection of the fact

that our first unit of energy will be used to supply our most critical needs, and after those needs are satisfied, the next units of energy will be used to satisfy less critical needs so that we are unwilling to pay as much for it.

Table 12 illustrates a representative set of bids and offers submitted by the buyers and sellers.

Table 12: Offers and bids for examples

Offers to sell		Bids to buy		
S1	S2	B1	B2	B3
\$10.00	\$10.00	\$70.00	\$70.00	\$25.00
\$50.00	\$50.00	\$70.00	\$50.00	0
\$65.00	\$70.00	\$65.00	\$25.00	0
\$70.00	\$70.00	\$65.00	0	0
∞	∞	0	0	0
∞	∞	0	0	0
∞	∞	0	0	0

Once each buyer and seller enters their data according to Table 12, the internet system will reconstruct the information according to Table 13, where

Table 13: Reconstructed offers and bids

Offer/bid order	Offers to sell 1 MWhr		Bids to buy 1 MWhr	
	Seller	Price	Buyer	Price
1	S1	\$10.00	B1	\$70.00
2	S2	\$10.00	B1	\$70.00
3	S1	\$50.00	B2	\$70.00
4	S2	\$50.00	B1	\$65.00
5	S1	\$65.00	B1	\$65.00
6	S2	\$70.00	B2	\$50.00
7	S1	\$70.00	B2	\$25.00
8	S2	\$70.00	B3	\$25.00

We can visualize the data in Table 13 by plotting the price against quantity for the offers and for the bids. This

provides us with the supply and demand schedules of Figure 29 [24].

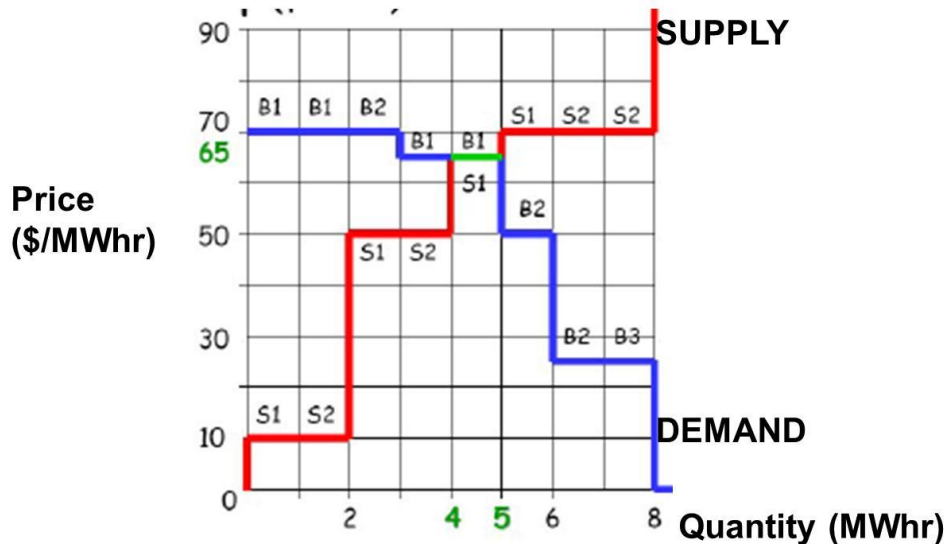

Figure 29: Supply-demand schedules illustrating electricity market operation [24]

The point (or those points) where the supply schedule intersects the demand schedule determines the market clearing price. This is the price that all sellers are paid to supply their energy, and it is the price that all buyers pay to receive their energy. In Figure, this price is \$65/MWhr. It is the very best price to choose because it maximizes the total “satisfaction” felt by the buyers and sellers.

This satisfaction, for the sellers, can be measured by the difference between the price they offered and the price they were actually paid for the energy they supplied. If we add up all of these differences for all sellers, then we obtain the net seller surplus. This satisfaction, for the buyers, can be measured by the difference between the price they bid and the price they actually had to pay for the energy they received. If we add up all of these differences for all sellers,

then we obtain the net buyer surplus. The net seller surplus and the net buyer surplus are illustrated in Fig. 30 [24].

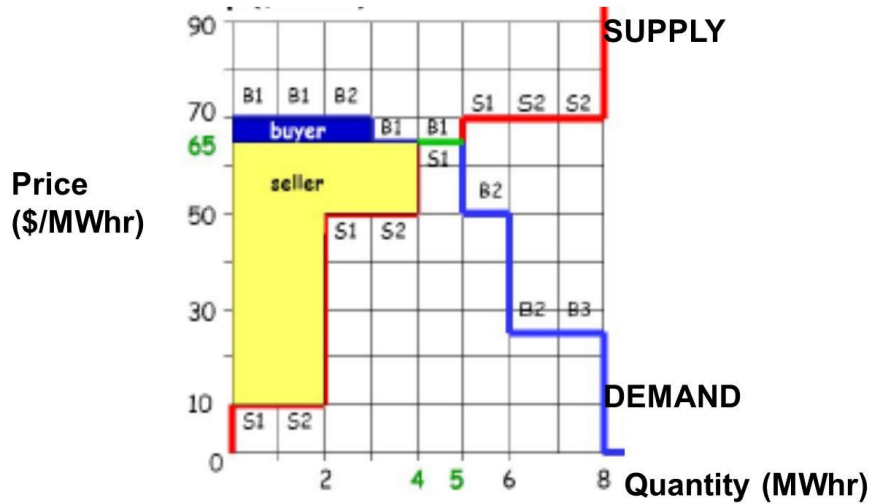

Figure 30: Illustration of net seller and net buyer surplus [24]

The total net surplus is the sum of the buyer and seller net surpluses. The market clearing price is the price that maximizes the total net surplus.

In Fig. 30, the quantity traded could be either 4 or 5 MWhrs, but the 5th MWhr would neither increase nor decrease the total net surplus. The decision on whether to trade 4 or 5 MWhrs in such as case is determined by market rules.

The example of this section illustrates the way electricity markets would clear if there are no losses and if the transmission capacity of each transmission circuit was infinite. One conceptualization of such a situation is when all generators and all loads are located at the same electric node. In such a case, there is a single price by which all sellers are paid and all buyers pay.

In reality, of course, each transmission circuit does have some resistance and therefore incurs some losses as current flows through it, and each transmission circuit also has an upper bound for the amount of power that can flow across it. These two attributes, losses and transmission limits, result in locational variation in prices throughout the network, which are called, as we have already seen, the locational marginal prices (LMPs).

9.0 Effect of Valve Points in Fossil-Fired Units

Figures 22 and 24 well represent cost curves of small steam power plants, but actual cost curves of large steam power plants differ in one important way from the curves shown in Figs. 22 and 24 – they are not smooth! The light curve of Fig. 31 [25] more closely captures the cost variation of a large steam power plant.

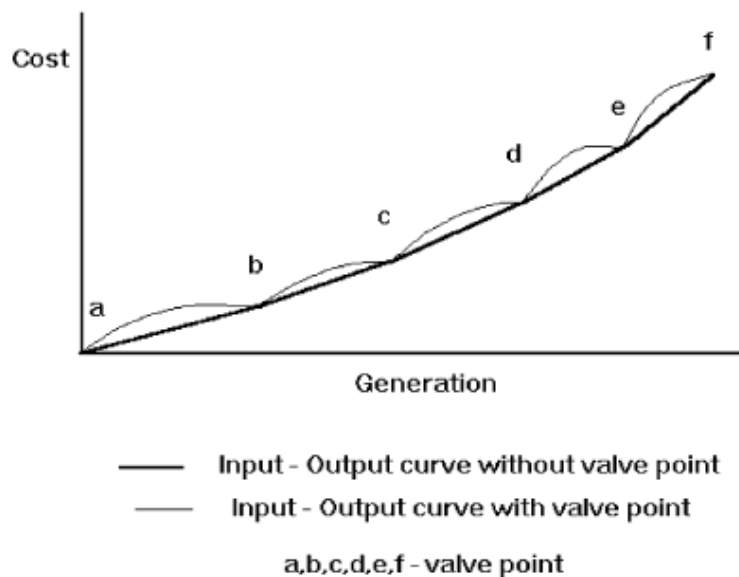

Fig. 31: Cost rate curve for large steam power plant [25]

The reason for the discontinuities in the cost curve of Fig. 31 is because of multiple steam valves. In this case, there are 5 different steam valves. Large steam power plants are operated so that valves are opened sequentially, i.e., power production is increased by increasing the opening of only a single valve, and the next valve is not opened until the previous one is fully opened. So the discontinuities of Fig. 31 represent where each valve is opened.

The cost curve increases at a greater rate with power production just as a valve is opened. The reason for this is that the so-called throttling losses due to gaseous friction around the valve edges are greatest just as the valve is opened and taper off as the valve opening increases and the steam flow smoothens.

The significance of this effect is that the actual cost curve function of a large steam plant is not continuous, but even more important, it is non-convex. A simple way (and the most common way) to handle these two issues is to approximate the actual curve with a smooth, convex curve, similar to the dark line of Fig. 31.

10.0 Combined cycle units

The following information was developed from [22, 26, 27, 28]. The below figure shows recent US growth in combined cycle power plants [29].

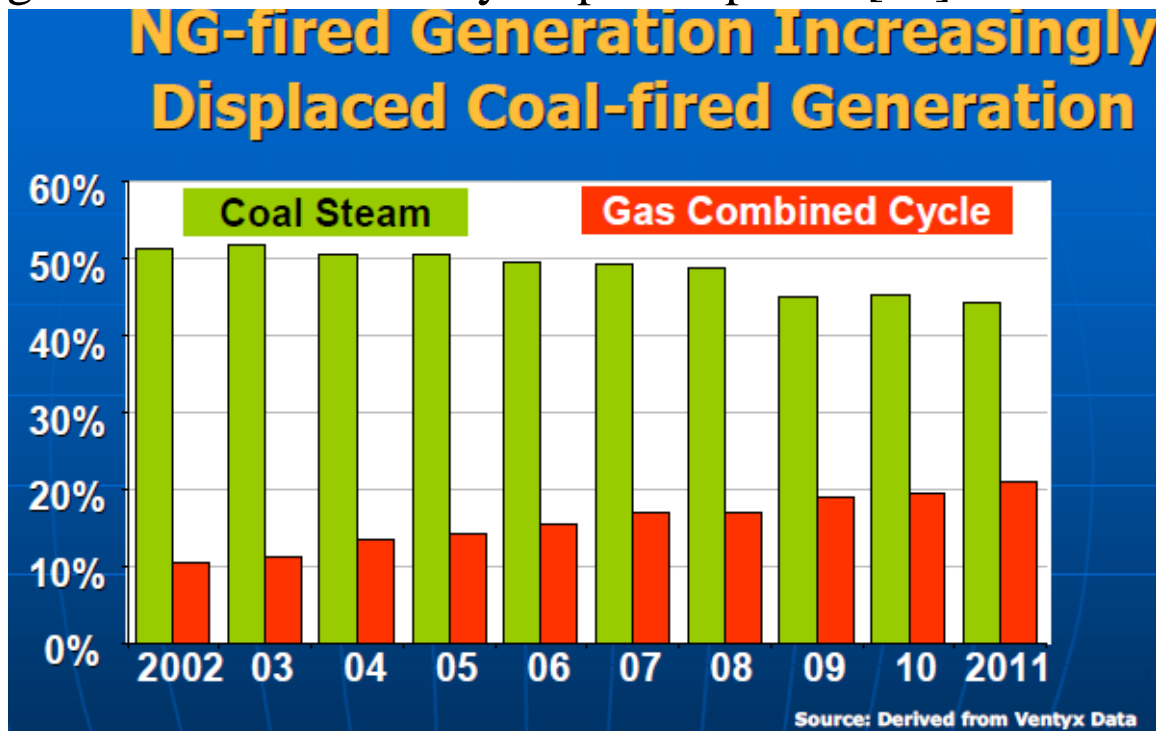

Fig. x

Combined cycle units utilize both gas turbines (based on the Brayton cycle) and steam turbines (based on the Rankine cycle). Gas turbines are very similar to jet engines where fuel (can be either liquid or gas) mixed with compressed air is ignited. The combustion increases the temperature and volume of the gas flow, which when directed through a valve-controlled nozzle over turbine blades, spins the turbine which drives a synchronous generator. On the

other hand, steam turbines utilize a fuel (coal, natural gas, petroleum, or uranium) to create heat which, when applied to a boiler, transforms water into high pressure superheated (above the temperature of boiling water) steam. The steam is directed through a valve-controlled nozzle over turbine blades, which spins the turbine to drive a synchronous generator.

A combined cycle power plant combines gas turbine (also called combustion turbine) generator(s) with turbine exhaust waste heat boiler(s) (also called heat recovery steam generators or HRSG) and steam turbine generator(s) for the production of electric power. The waste heat from the combustion turbine(s) is fed into the boiler(s) and steam from the boiler(s) is used to run steam turbine(s). Both the combustion turbine(s) and the steam turbine(s) produce electrical energy. Generally, the combustion turbine(s) can be operated with or without the boiler(s).

A combustion turbine is also referred to as a simple cycle gas turbine generator. They are relatively inefficient with net heat rates at full load of some plants at 15 MBtu/MWhr, as compared to the 9.0 to 10.5 MBtu/MWhr heat rates typical of a large fossil fuel fired utility generating station. This fact, combined with what can be high natural gas prices,

make the gas turbine expensive. Yet, they can ramp up and down very quickly, so as a result, combustion turbines have mainly been used only for peaking or standby service.

The gas turbine exhausts relatively large quantities of gases at temperatures over 900 °F. In combined cycle operation, then, the exhaust gases from each gas turbine will be ducted to a waste heat boiler. The heat in these gases, ordinarily exhausted to the atmosphere, generates high pressure superheated steam. This steam will be piped to a steam turbine generator. The resulting combined cycle heat rate is in the 7.0 to 9.5 MBtu/MWhr range, significantly less than a simple cycle gas turbine generator.

In addition to the good heat rates, combined cycle units have flexibility to utilize different fuels (natural gas, heavy fuel oil, low Btu gas, coal-derived gas) [30]. (In fact, there are some advanced technologies under development right now, including the *integrated gasification combined cycle* (IGCC) plant, which makes it possible to run combined cycle on solid fuel (e.g., coal or biomass) [31]. The first two operational IGCC plants in the US were the Polk Station Plant in Tampa and the Wabash River Plant in Indiana [32]. The Ratcliffe-Kemper plant, currently under construction by Mississippi Power (a

subsidiary of Southern Company), is a 582 MW IGCC plant, to be completed in 2014 [33, 34].)

The flexibility of combined cycle plants, together with the fast ramp rates of the combustion turbines and relatively low heat rates, has made the combined cycle unit the unit of choice for a large percentage of recent new power plant installations. The potential for increased gas supply and lowered gas prices has further stimulated this tendency.

Fig. 32 shows the simplest kind of combined cycle arrangement, where there is one combustion turbine and one HRSG driving a steam turbine.

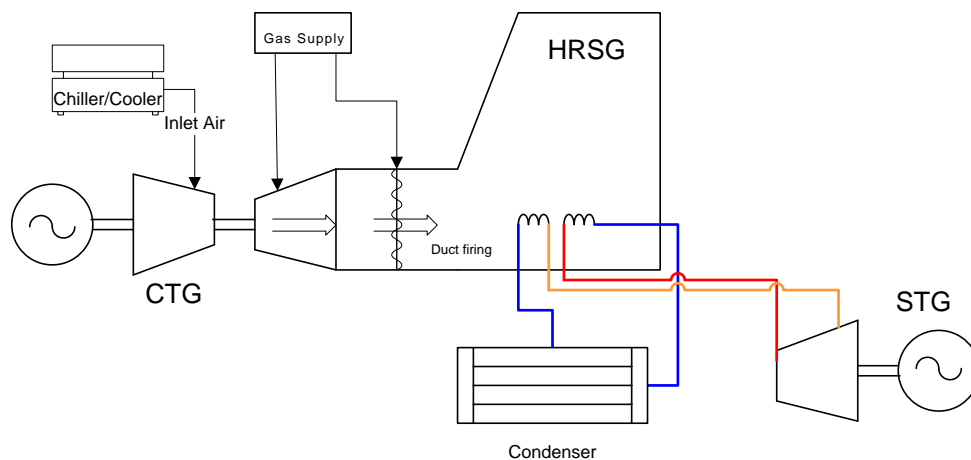

Fig. 32: A 1×1 configuration

An additional level of complexity would have two combustion turbines (CT A and B) and their HRSGs driving one steam turbine generator (STG), as shown in Fig. 33.

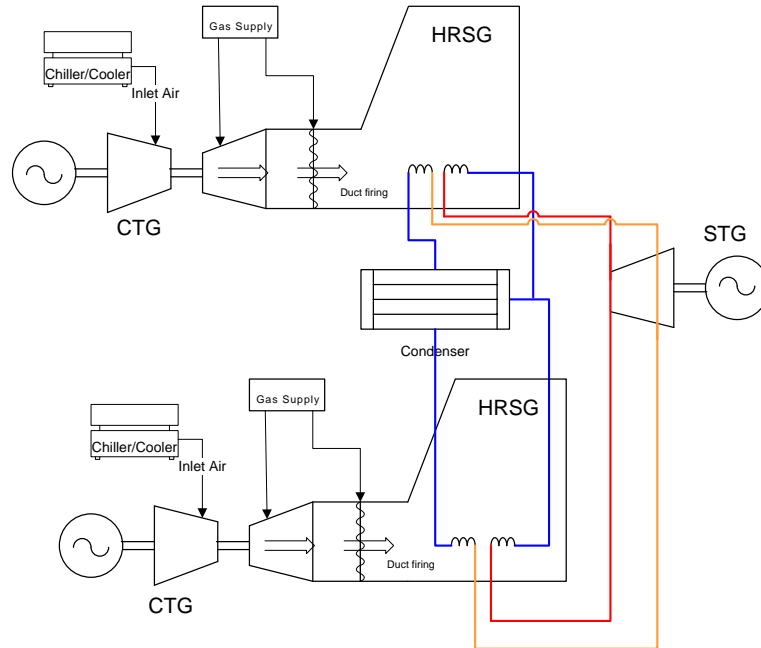

Fig. 33: a 2×1 configuration

In such a design, the following six combinations are possible.

- CT A alone
- CT B alone
- CT A and CT B together
- CT A and STG
- CT B and STG
- CT A and B and STG

The modes with the STG are more efficient than the modes without the STG (since the STG utilizes CT exhaust heat that is otherwise wasted), with the last mode listed being the most efficient.

If we model a combined cycle plant as a single plant, we run into a problem. Consider the transition between the combined cycle power plant operation

just as the STG is ramped up. Previous to STG start-up, only the CT is generating, with a specified amount of fuel per hour being consumed, as a function of the CT power generation level. Then, after STG start-up, the fuel input remains almost constant, but the MW output of the (now) two generation units has increased by the amount of power produced by the steam turbine driven by the STG. A typical cost curve for this situation is shown in Fig. 34.

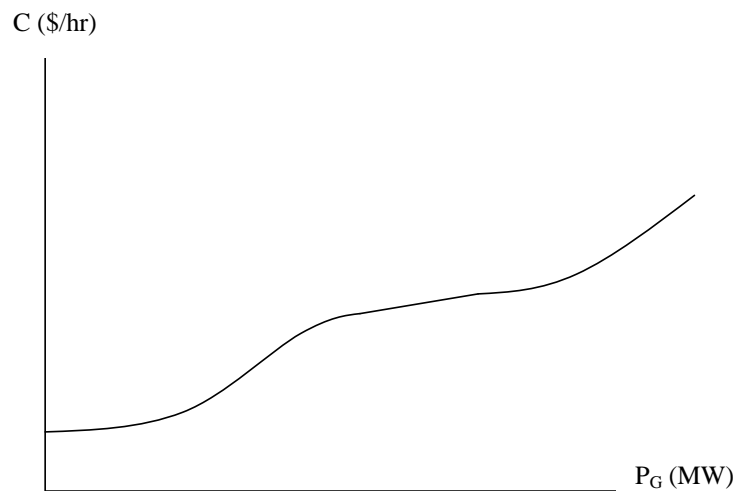

Fig. 34: Cost curve for a combined cycle plant

An important feature of the curve in Fig. 34 is that it is not convex, which means its slope (i.e., its incremental cost) does not monotonically increase with P_G . Figure 35 illustrates incremental cost variation with P_G .

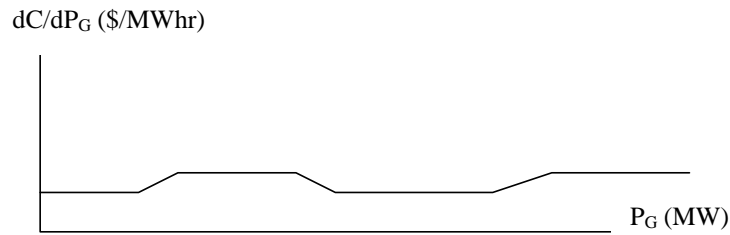

Fig. 35: Incremental cost curve for a combined cycle plant

The key attribute of the incremental cost curve, in order to satisfy convexity, is that it must be non-decreasing. Clearly, the curve of Fig. 35 does not satisfy this requirement.

11.0 Economic dispatch and convexity of objective functions in optimization

The traditional economic dispatch (ED) approach used by electric utilities for many years is very well described in [35].

This approach is still used directly by owners of multiple generation facilities when they make one offer to the market and then need to dispatch their units in the most economic fashion to deliver on this offer. This approach also provides one way to view the method by which locational marginal prices are computed in most of today's real-time market systems.

The simplest form of the ED problem is as follows:

Minimize:

$$F_T = \sum_{i=1}^n F_i(P_i) \quad (1)$$

Subject to:

$$\sum_{i=1}^n P_i = P_{load} \implies \phi(P_i) = P_{load} - \sum_{i=1}^N P_i = 0 \quad (2)$$

$$\begin{aligned} P_i &\geq P_{i,\min} \implies -P_i \leq -P_{i,\min} \\ P_i &\leq P_{i,\max} \\ P_i &\geq 0 \end{aligned} \quad (3)$$

Here, we note that the equality constraint is linear in the decision variables P_i . In the Newton approach to solving this problem ([35]), we form the Lagrangian according to:

$$\mathcal{L} = F_T(P_i) + \lambda\phi(P_i) \quad (4)$$

If each and every individual cost curve $C_i(P_i)$, $i=1,n$, is quadratic, then they are all convex. Because the sum of convex functions is also a convex function, when all cost curves are convex, then the objective function $F_T(P_i)$ of the above problem is also convex. If $\phi(P_i)$ is linear, then it is convex, and therefore \mathcal{L} is convex. This fact allows us to find the solution by applying *first order conditions*.

First order conditions for multi-variable calculus are precisely analogous to first order conditions to single variable calculus. In single variable calculus, we minimize $f(x)$ by solving $f'(x)=0$, on the condition that $f(x)$ is convex, or equivalently, that $f''(x)>0$.

In multivariable calculus, where $\underline{x}=[x_1 \ x_2 \dots \ x_n]^T$, we minimize $f(\underline{x})$ by solving $f'(\underline{x})=\underline{0}$, that is,

$$\frac{\partial f}{\partial x_i} = 0, \quad i = 1, n \quad (5)$$

on the condition that $f(\underline{x})$ is convex or equivalently, that the Hessian matrix $f''(\underline{x})$ is positive definite.

We recall that, in single variable calculus, if $f(x)$ is not convex, then the first order conditions do not guarantee that we find a *global* minimum. We could find a maximum, or a local minimum, or an inflection point, as illustrated in Fig. 36 below.

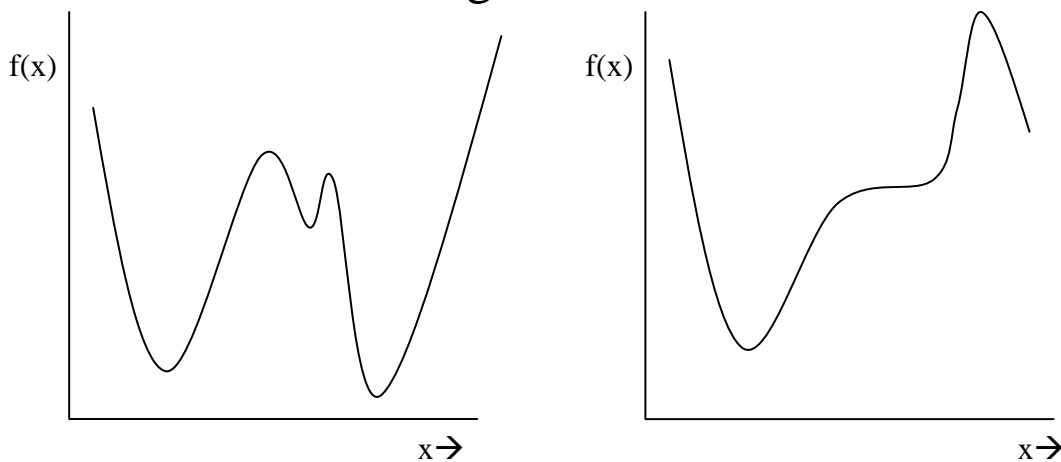

Fig. 36: Non-convex functions

The situation is the same in the multivariable case, i.e., if $f(\underline{x})$ is not convex, then the first order conditions of (5) do not guarantee a global minimum.

Now returning to the Lagrangian function of our constrained optimization problem, repeated here for convenience:

$$\mathcal{L} = F_T(P_i) + \lambda\phi(P_i) \quad (4)$$

we recall that solution to the original problem is found by minimizing F_T . But, to use what we now know, we are only guaranteed to find a global minimum of F if \mathcal{L} is convex. In this case, the first order conditions results in

$$\frac{\partial \mathcal{L}}{\partial P_i} = 0, \quad i = 1, N$$

$$\frac{\partial \mathcal{L}}{\partial \lambda} = 0$$

from which we may find our solution (Inequality constraints may be handled by checking the resulting solution against them, and for any violation, setting up another equality constraint which binds the given decision variable to the limit which was violated).

But if one of the units is a combined cycle unit, the F_T , and therefore \mathcal{L} , will not be convex. So, first

order conditions do not guarantee a global minimum. In other words, there may be a lower-cost solution than the one we will obtain from applying first order conditions. This makes engineers and managers concerned, because they worry they are spending money unnecessarily.

12.0 General solutions for non-convex optimization problems

Generation owners who utilize combined cycle units must use special techniques to solve the EDC problem. Some general methods that have been proposed for solving non-convex optimization problems are below. However, I am not aware that any of these techniques have been implemented within an electricity market today.

1. Enumeration/Iteration: In this method, all possible solutions are enumerated and evaluated, and then the lowest cost solution is identified. This method will always work but can be quite computational.
2. Dynamic programming: See pp. 51-54 of reference [22].

3. Sequential unconstrained minimization technique (SUMT): This method is described on pp 473-477 of reference [36].

4. Heuristic optimization methods: There are a number of methods in this class, including Genetic Algorithm simulated annealing, tabu search, and particle swarm. A good reference on these methods is [37].

5. There is a matlab toolbox for handling non-convex optimization. It provides 2 different algorithms together with references on papers that describe the algorithms, located at <http://tomlab.biz/>. There are two methods provided

(a) Radial Basis Function (RBF) interpolation:

(b) Efficient Global Optimization (EGO) algorithm: The idea of the EGO algorithm is to first fit a response surface to data collected by evaluating the objective function at a few points. Then, EGO balances between finding the minimum of the surface and improving the approximation by sampling where the prediction error may be high.

13.0 Practical solutions to modeling combined cycle units in optimization

Reference [38], developed by engineers at ERCOT and Ventyx (now ABB), is an excellent summary of practical methods to modeling combined cycle units. It provides references to a number of other good resources on the subject. The methods it outlines are as follows:

- **Aggregate modeling:** Here, the combined cycle unit is simply modeled with a “best-fit” convex cost curve. This approach does not handle the non-convexity of the actual cost characteristic.
- **Pseudo-unit modeling:** Here, a number of pseudo-units equal to N , the number of combustion turbines are represented, each with $1/N$ of the steam unit. This works for an $N \times 1$ combined cycle unit. For example, a 3×1 combined cycle unit would be modeled as three separate pseudo-units; each of the three pseudo-units would be one gas turbine plus one third of a steam turbine [39]. This approach has been implemented within several markets, including ISO NE, NYISO, MISO, PJM, and IESO. This approach does not handle the non-convexity of the actual cost characteristic.
- **Configuration-based modeling:** This approach is also referred to as pseudo-plant modeling. Here, a cost-curve (or incremental cost curve) is provided for each configuration of the combined cycle plant. Additional logic is provided in the security-constrained unit commitment (SCUC, which is the mixed integer programming software for the day-ahead market) to ensure that only one configuration can be selected, and that the selection depends on the configuration of the previous time period, as illustrated in Fig. 37 below for a 2×1 combined cycle plant [38]. The configuration

chosen by SCUC for any one hour is maintained for the entire hour in the real-time market. CAISO has implemented this approach, it is well-described in [39].

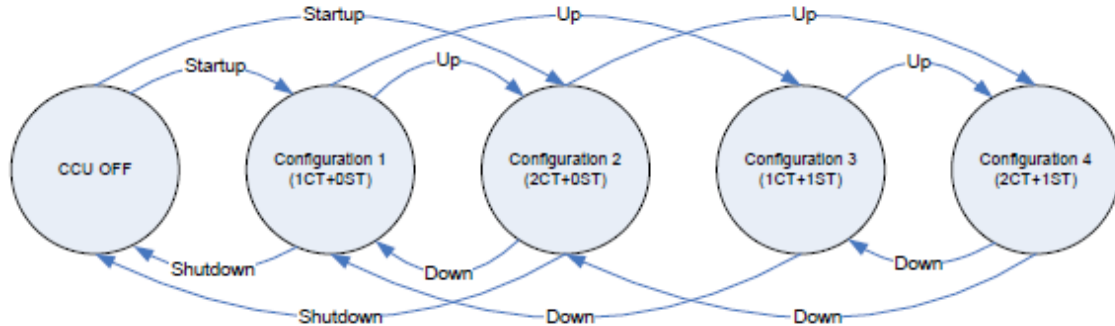

Fig. 37

- Physical-unit modeling: Here, each CT and STG is considered to be an individual resource with its own individual offers. This is a bad market model but it provides good fidelity in terms of MW that the power plant can actually produce. ERCOT reports in [39] that it utilizes configuration-based models for its markets and physical unit modeling for its network security applications.

References

- [1] J. McCalley, W. Jewell, T. Mount, D. Osborn, and J. Fleeman, "A wider horizon: Technologies, Tools, and Procedures for Energy System Planning at the National Level," IEEE Power and Energy Magazine, May/June, 2011.
- [2] J. Morgan, "Energy Density and Waste Comparison of Energy Production," Nuclear Science and Technology, June 2010, available at <http://nuclearfissionary.com/2010/06/09/energy-density-and-waste-comparison-of-energy-production>.
- [3] The World Nuclear Association, "The Economics of Nuclear Power," available at <http://www.world-nuclear.org/info/inf02.html>.
- [4] U.S. Department of Energy, Energy Information Administration website, located at http://www.eia.gov/cneaf/electricity/epm/epmxf4_1.xls and http://www.eia.doe.gov/cneaf/electricity/epm/epmxf4_1_cont.xls
- [5] U.S. Department of Energy, Energy Information Administration website, located at <http://www.eia.doe.gov/emeu/aer/txt/ptb0811b.html>.
- [6] "Energy perspectives 2011, US Department of Energy, Energy Information Administration website, http://www.eia.gov/totalenergy/data/annual/pdf/perspectives_2011.pdf.

- [7] North American Reliability Corporation (NERC), “2011 Long Term Reliability Assessment,” November 2011, available at www.nerc.com.
- [8] U.S. Department of Energy, Energy Information Administration website, located at <http://www.eia.doe.gov/oiaf/aeo/coal.html>
- [9] Wikipedia page on “Greenhouse gas”: http://en.wikipedia.org/wiki/Carbon_emissions
- [10] US Department of Energy, Energy Information Administration, “Emissions of Greenhouse Gases in the United States 2006,” November 2007, available at <http://www.eia.doe.gov/oiaf/1605/ggrpt/index.html>.
- [11] US Department of Energy, Energy Information Administration, “Emissions of Greenhouse Gases in the United States 2008,” December 2009, available at <http://www.eia.doe.gov/oiaf/1605/ggrpt/index.html>.
- [12] www.eia.doe.gov/oiaf/1605/1605aold.html.
- [13] DOE EIA, “Frequently Asked Questions,” <http://www.eia.gov/tools/faqs/faq.cfm?id=77&t=11>
- [14] DOE EIA, Data from Voluntary Reporting of Greenhouse Gases Program, available at <http://www.eia.doe.gov/oiaf/1605/coefficients.html>.
- [15] F. Van Aart, “Energy efficiency in power plants,” October 21, Vienna, available from Dr. McCalley (see “New Generation” folder), but you must make request.
- [16] EPA report, www.epa.gov/airmarkt/progsregs/epa-ipm/docs/chapter8-v2_1-update.pdf.
- [17] Black & Veatch, “Planning for Growing Electric Generation Demands,” slides from a presentation to Kansas Energy Council – Electric Subcommittee, March 12, 2008, available at http://www.google.com/search?hl=en&source=hp&q=%22Planning+for+Growing+Electric+Generation+Demands%22&btnG=Google+Search&aq=f&aql=&aql=&oq=&gs_rfai=C5Ekv4uV7TP7ECIzmNJHV_MIEAAAqgOFT9Dr5Lw.
- [18] DOE EIA Website for US locations emission coefficients, <http://www.eia.doe.gov/oiaf/1605/ee-factors.html>.
- [19] www.rutlandherald.com/apps/pbcs.dll/article?AID=/20080706/NEWS04/807060457/1024/NEWS04
- [20] H. Stoll, “Least-cost electric utility planning,” 1989, John Wiley.
- [21] D. Kirschen and G. Strbac, “Fundamentals of Power System Economics,” Wiley, 2004.
- [22] A. J. Wood and B. F. Wollenberg, Power, Generation, Operation and Control, second edition, John Wiley & Sons, New York, NY, 1996.
- [23] J. Klein, “The Use of Heat Rates in Production Cost Modeling and Market Modeling,” California Energy Commission Report, 1998.
- [24] L. Tesfatsion, “Auction Basics for Wholesale Power Markets: Objectives and Pricing Rules,” Proceedings of the 2009 IEEE Power and Energy Society General Meeting, July, 2009.
- [25] J. Kim, D. Shin, J. Park, and C. Singh, “A tavistic genetic algorithm for economic dispatch with valve point effect,” *Electric Power Systems Research*, 62, 2002, pp. 201-207.
- [26] “Electric power plant design,” chapter 8, publication number TM 5-811-6, Office of the Chief of Engineers, United States Army, January 20, 1984, located at <http://www.usace.army.mil/publications/armytm/tm5-811-6/>, not under copyright.
- [27] A. Cohen and G. Ostrowski, “Scheduling units with multiple operating modes in unit commitment,” *IEEE ???*, 1995.
- [28] A. Birch, M. Smith, and C. Ozveren, “Scheduling CCGTs in the Electricity Pool,” in “Opportunities and Advances in International Power Generation, March 1996.
- [29] 2011 State of the Markets, a FERC presentation, April 2012, at <https://www.ferc.gov/market-oversight/reports-analyses/st-mkt-ovr/som-rpt-2011.pdf>.
- [30] R. Tawney, K. Kamali, W. Yeager, “Impact of different fuels on reheat and nonreheat combined cycle plant performance,” Proceedings of the American Power Conference; Vol/Issue: 50; American power conference; 18-20 Apr 1988; Chicago, IL (USA).
- [31] I. Burdon, “Winning combination [integrated gasification combined-cycle process],” *IEE Review*, Volume: 52, Issue: 2, 2006, pp. 32 – 36, *IET Journals & Magazines*.
- [32] www.fossil.energy.gov/programs/powersystems/gasification/gasificationpioneer.html
- [33] “Southern Company on track with new generation,” Investopedia, March 23, 2011, available at <http://www.investopedia.com/stock-analysis/2011/southern-company-on-track-with-new-generation-so-d-duk0323.aspx#axzz28iY0dqaR>.
- [34] www.southerncompany.com/smart_energy/smart_power_vogtle-kemper.html
- [35] G. Sheble and J. McCalley, “Module E3: Economic dispatch calculation,” used in EE 303 at Iowa State University.

-
- [36] F. Hillier and G. Lieberman, "Introduction to Operations Research," fourth edition, Holden-Day, 1986.
- [37] "Tutorial on modern Heuristic Optimization Techniques with Applications to Power Systems," IEEE PES Special Publication 02TP160, edited by K. Lee and M. El-Sharkawi, 2002.
- [38] H. Hui, C. Yu, F. Gao, and R. Surendran, "Combined cycle resources scheduling in ERCOT nodal market," Proc. of the 2011 IEEE PES General Meeting, 2011.
- [39] "Modeling of Multi-Stage Generating Units," CAISO. Available at www.caiso.com/2358/2358e27f11070.pdf.